

Surgical Table Accessories

600 lb. (272 kg)
Patient Wt. Capacity

FACC0055



Simple squeeze of the Trigger Grip Handle for lithotomy and abduction/adduction.

EZ-Lift Power Assist Boot Stirrups with Boot Pads

- 600 lb (272 kg) surgical patient weight capacity
- Boot free-floats throughout each range reducing the risk of superficial nerve injury
- Raise, lower, abduct, adduct quickly and easily with the Trigger Grip handle
- Lithotomy and length indicators help to position and reposition the legs
- Deluxe boot stirrup liners wrap around the foot, ankle and calf providing safe, comfortable and secure patient positioning

Increase your surgeons' operating room performance with the EZ-Lift Power Assist Boot Stirrups which permits simple adjustment of lithotomy and abduction intraoperatively. A simple squeeze of the Trigger Grip trigger provides complete control of lithotomy and abduction/adduction without compromising the sterile field. Simply release the trigger on the handle to securely lock the stirrup in all directions. Quick-connect, blade-mounting style with extended lateral boot system, the EZ-Lift Power Assist Boot Stirrups' range of motion is -35° low lithotomy to 84° high lithotomy. Adduction -9° and abduction 25° , with the control to lock the stirrup anywhere in between. The stirrup ships fully assembled. Boot liners are included. Two required SpringLoc Clamps sold separately.



Organize your accessories with the Stirrup Dolly (left) and Stirrup Wall Rack (right).

Optional Accessories:

FACC0064 - FHC Stirrup Cart

FACC0066 - Stirrup Wall Rack

Required Accessory: (Purchase Two)

FACC0011 SpringLoc Clamp



Surgical Table Accessories

Pediatric EZ-Lift Stirrups

- Floating boot automatically adjusts when repositioning the pediatric boot stirrup
- Range: Abduction +25°, Adduction -9°
- Lithotomy range of +84° to -35°
- Easy-clean Boot Liner Pad safely wraps patient's foot, ankle and leg
- Visual indicators ensure precise patient positioning

FACC0052	Pediatric E-Z Lift Stirrups, PUPS 160 lb (73 kg) patient capacity
FACC0051	Pediatric E-Z Lift Stirrups, KIDS 250 lb (113 kg) patient capacity
FACC0050	Pediatric E-Z Lift Stirrups Bundle Includes 1 pair of each stirrups

Required Accessory: Order Two
FACC0011 SpringLoc Clamp



The Pediatric E-Z Lift Stirrups are as easy-to-use as its forerunner; providing a comfortable, stable boot with an easy-clean boot liner that safely and securely wraps the foot, ankle and leg. Stirrups with the E-Z Lift feature easily control the patient's leg when moving it into the operative position, and have a Trigger Grip Handle that permit simple adjustment of lithotomy, adduction/abduction, and intraoperatively while maintaining a sterile field. Boot adjust with a single clamp, simplifying patient positioning. Boot liners included.

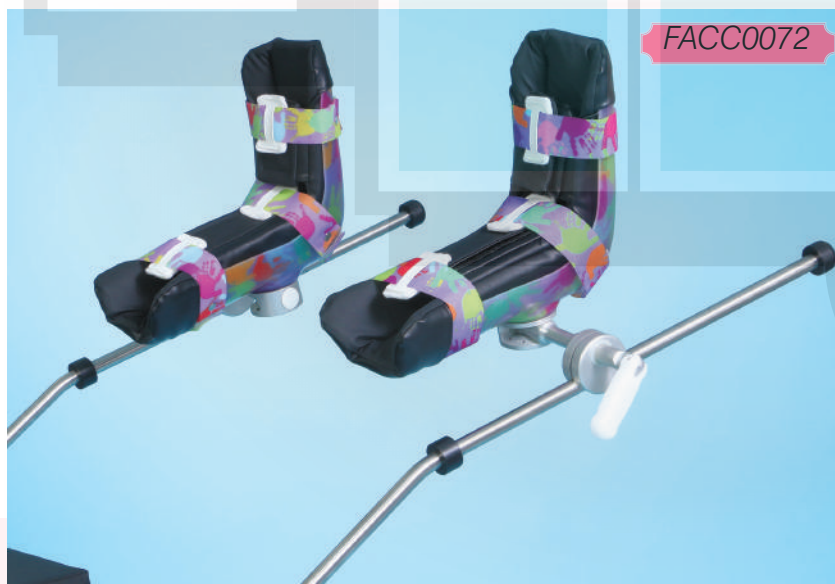

The Pediatric Lithotomy Stirrups are a comfortable boot stirrup with an easy-clean boot liner that is specifically designed with the pediatric patient in mind. Safely and securely wrapping the foot, ankle and leg, the boot adjusts with a single clamp that simplifies patient positioning. Pediatric stirrups attach to side rail of any OR table using the Schure Socket XL (sold separately). Boot liners are included.

Pediatric Lithotomy Stirrups

- Pediatric boot stirrup design encapsulates patient's lower leg
- Floating boot automatically adjusts when repositioning the pediatric boot stirrup
- Replaceable boot liner pad safely wraps patient's foot, ankle and calf
- Single boot clamp makes positioning the patient easy

FACC0073	Pediatric Lithotomy Stirrups, PUPS 160 lb (73 kg) patient capacity
FACC0072	Pediatric Lithotomy Stirrups, KIDS 250 lb (113 kg) patient capacity
FACC0074	Pediatric Lithotomy Stirrups Bundle Includes 1 pair of each stirrups

Required Accessory: Order Two
FACC0011 SpringLoc Clamp

Surgical Table Accessories

800 lb. (363 kg)
Patient Wt. Capacity

FACC0054



Fold-over design
Flexible boot

Required Accessory: (Purchase Two)
FACC0011 SpringLoc Clamp



Maxima Power Assist Boot Stirrups

- 800 lb (363 kg) surgical patient weight capacity
- Boot free-floats throughout each range reducing the risk of superficial nerve injury
- Raise, lower, abduct, adduct quickly and easily with the Trigger Grip Handle
- Lithotomy and length indicators help to position and reposition the legs
- Extended lateral boot design helps reduce the risk of peroneal nerve injury

Increase your surgeons' operating room performance with the EZ-Lift Power Assist Maxima Stirrups which permit simple adjustment of lithotomy and abduction intraoperatively. A simple squeeze of the Trigger Grip Handle provides complete control of lithomy and abduction/adduction without compromising the sterile field. Quick connect blade-mounting style with extended lateral boot system. Deluxe boot stirrup liners wrap around the foot, ankle and calf providing safe, comfortable and secure patient positioning. EZ-Lift Power Assist Maxima Stirrups range of motion is -35° low lithotomy to 84° high lithotomy. Adduction -9° and abduction 25° , with the control to lock the stirrup anywhere in between. The EZ-Lift Power Assist ships fully assembled. Boot liners are included. Two required SpringLoc Clamps sold separately.



Surgical Table Accessories



Uro-Trapper System

- Flexible drape support provides unobstructed surgeon access to surgical site and springs back to original orientation to allow for optimal fluid drainage
- Mounts effortlessly to any surgical table with integral clamps

A flexible system that attaches to any general surgical table to contain fluids for hysteroscopy or cystoscopy procedures.

FACC0030 Uro-Trapper System

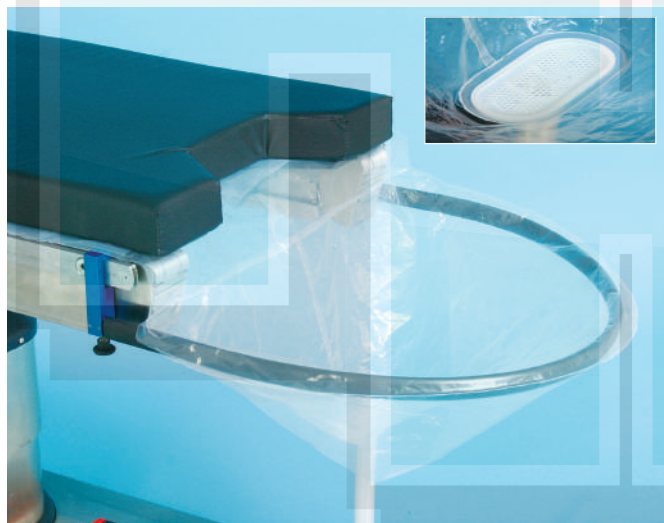

Uro-Trapper Drain Bags

- Flexible hose is compatible with all suction systems for accurate fluid measurement
- Durable, drain bags are not made with natural rubber latex

Open mesh filter allows for rapid drainage of fluids.

Tube is 64"L x $\frac{7}{8}$ "D (163cm x 2cm) and 20" (51cm) compressed.

Disposable Uro-Trapper Drain Bags

FACC920-0098 Sterile, 10/cs

FACC0031 Non-Sterile, 10/cs



Disposable Clear View Leg Drapes

The Disposable Clear View Leg Drape allows visibility of patient's leg during intraoperative adjustments. A blue modesty panel is now incorporated within the drape. Packaged sterile and not made with natural rubber latex. Provides continuous monitoring of patient's legs without breaking sterile field.

FACC920-0160 Disposable Clear View Leg Drapes, Sterile, 10/cs

Surgical Table Accessories

Lithotomy Stirrups

- Use for long or short procedures
- Soft boot liners encapsulate feet
- 350 lb (158 kg) patient weight capacity
- Features extended lateral boot support to prevent superficial nerve damage and unwanted leg rotation
- Schure Socket XL sold separately

FACC0071 Lithotomy Stirrups

FACCF-RCP2 Schure Socket XL



Knee Crutches

- Simple to set up and position the patient
- Knee Crutches adjust vertically from 12"-19" (31cm-48cm) and rotate 360° to provide precise positioning with a simple ergonomic locking handle
- Constructed of the highest quality stainless steel
- Extremely soft and comfortable crutch liners prevent superficial nerve damage to the patient. Mount crutches simply with Schure Socket XL (sold separately)

FACC0019 Knee Crutches

FACCF-RCP2 Schure Socket XL



Candy Cane Stirrups

- Adjust vertically from 28"-44" (71cm-112cm) with an 8" (20cm) leg clearance
- 18"L x 1 1/2"W (46cm x 4cm) double-looped, cotton ankle strap
- Lock stirrup height by simply twisting the ergonomic handle
- Connect stirrups to OR table side rail with Schure Socket XL (sold separately)

FACC0020 Candy Cane Stirrups

FACCF-RCP2 Schure Socket XL
358LC Candy Cane Strap Replacement
FACC508-0453 Gel Candy Cane Pole Pad,
25" L x 2" I.D. (64 cm x 5cm)



Surgical Table Accessories



FACC0169

Schure Loc™ XPS Positioner

- Securely and safely holds patient arm in any desired position during arthroscopic surgery
- Compact and lightweight
- No foot pedals, hoses, hydraulics or power cords
- Ships assembled and ready for immediate use
- Single lever releases all joints for positioning and re locks when released
- Decreases surgeon fatigue and improves intraoperative control of surgical limb
- Schure Loc™ XPS reduces staffing needs providing a more cost-effective procedure
- Schure Loc™ XPS Shoulder Kit conveniently includes a sterile drape and foam hand/forearm holder, and self-adherent wrap

Schure Loc™ XPS currently outperforms similar equipment for shoulder surgery in both the beach chair and lateral position. The Schure Loc™ XPS is the perfect companion piece for any beach chair positioner—easily attaching to any OR table rail while freeing your surgical assistant to do much more than steady the patient's limb. Get the most from your team by adding this high-quality, easy-to-use device to your shoulder surgery equipment.

Easy as 1, 2, 3

- Squeeze and hold lever to release all device joints
- Position limb in exact position
- Release lever to securely lock into position

FACC0169 Schure Loc™ XPS

Optional Accessory
FACC920-0281 Disposable Schure Loc™ XPS Sterile Kit, 10/cs
Includes Sterile Forearm Wrap, Sterile Self-Adherent Coban™ and Sterile Drape.



Surgical Table Accessories

Completely eliminates manual positioning with push-button ease

FACC0043



FHC Powered Beach Chair

- 500 lb (227 kg) patient weight capacity
- Motion-control technology eliminates manual patient positioning
- Lateral Brace attaches to chair and not table side rail
- Pull-away panels providing excellent surgical exposure
- Double-ball joint head rest tilts 30° in every direction
- Five-piece Deluxe pad set included

The FHC Powered Beach Chair is the only chair on the market with a self-contained motor that does not have to rely on the surgical table for power. The double-ball joint head system safely secures patient's head; with even your kyphosis patients. Chair adjusts from 0-90° in 8 seconds in a slow controlled movement. 2" (5cm) Deluxe pad set provides patient comfort. Motion-control technology eliminates manual patient positioning with a simple push button hand control and supports patients up to 500 lbs (227 kgs). Attaches to ANY operating room table with our integrated adjustable mounting clamps. Lateral Brace included.

FACC0043 Powered Beach Chair

Required Accessories: Select One Model
 FACC920-0164 Disposable Face Masks, 12/cs
 FACC920-0039 Disposable Head & Chin Straps, 12/cs

Optional Accessories
 FACC0065 Dolly, Shoulder Chair
 FACC0010 Multi-Axis Arm Positioner
 FACCF-RCP2 Schure Socket XL



Disposable Face Mask



Disposable Head & Chin Strap



Multi-Axis Arm Positioner



Schure Socket XL



Shoulder Chair Dolly



Complete Shoulder System includes the Schure Loc™ XPS, Disposable Head & Chin Straps, Multi-Axis Arm Positioner, Schure Socket XL, Disposable Schure Loc™ XPS Sterile Kit and Schure Loc Carrying Case.

Choose Powered Beach Chair or E-Z Lift Beach Chair

FACC0058 Complete Shoulder System w/Schure Loc™ XPS & Powered Beach Chair

FACC0059 Complete Shoulder System w/Schure Loc™ XPS & E-Z Lift Chair

Surgical Table Accessories



FACC0042

FHC EZ-Lift Beach Chair

- Reduces effort when lifting patients compared to manual systems
- Double-ball joint head system safely secures patient's head

The FHC Beach Chair provides a lightweight and cost-effective option to our fully powered shoulder chair. This system employs a powerful piston to lift the patient. Adjusts to fit any OR table with our integrated adjustable mounting clamps. 500 lb (227 kg) patient weight capacity. Articulation range is 0°–90°. Lateral Brace included.

FACC0042 FHC EZ-Lift Beach Chair

Required Accessories: Select One Model

FACC920-0164 Disposable Face Masks, 12/cs

FACC920-0039 Disposable Head & Chin Straps, 12/cs

Optional Accessories

FACC0065 Dolly, Shoulder Chair

FACC0010 Multi-Axis Arm Positioner

FACCF-RCP2 Schure Socket XL



Disposable Face Mask



Disposable Head & Chin Strap



Multi-Axis Arm Positioner



Schure Socket XL



Shoulder Chair Dolly

Complete Shoulder System includes the Shoulder Assistant, Disposable Head & Chin Straps, Multi-Axis Arm Positioner, Shoulder Assistant Dolly, Schure Socket XL and the Disposable Hand / Forearm Wraps.

Choose FHC Beach Chair or Powered Beach Chair

FACC0048 Complete Shoulder Assistant Powered Beach Chair Shoulder System

FACC0060 Complete Shoulder Assistant FHC Chair Shoulder System

Surgical Table Accessories

FACC0047



Shoulder Assistant

- Save money not having to buy expensive drapes
- Surgeon foot control provides quick and precise intraoperative positioning
- Easy-to-assemble
- Shoulder Assistant Dolly sold separately
- Unlimited surgical site access and positioning

The FHC Shoulder Assistant combines strength and adaptability to provide optimal intraoperative positioning for shoulder surgery in the beach chair position. Staff efficiency is improved as the assistants are freed from holding the limb during surgery. Designed to maintain a low profile while delivering exceptional control and positioning capabilities. Mounts onto the side of any standard operating table and provides a non-sterile base for which sterile components are inserted. The upper extremity positioner and control tube are steam autoclavable to provide the sterile environment needed for upper extremity surgery.

FACC0047 Shoulder Assistant

Required Accessory

Disposable Sterile Hand/Forearm Wraps securely holds the hand and forearm during the operative procedure. Quick release for range of motion.

FACC920-0113 Disposable Sterile Hand/Forearm Wraps, 12/cs



FACC920-0039



FACC920-0164



FACC0081

Optional Accessories

FACC920-0039

Disposable Head & Chin Straps,
12/cs

FACC920-0164

Disposable Face Masks, 12/cs

FACC0081

Dolly, Shoulder Assistant

Surgical Table Accessories

Lateral Shoulder Holder

This weightless shoulder system allows for traction settings from 0-25 lbs (0-11 kgs) by simply turning the traction adjustment knob. Internal and external rotation can be easily controlled by the surgeon's preference, and locked in place. It simply attaches to the surgical table side rail. No need for sand bags!

Required CamLoc Clamp sold separately.

FACC0170 Lateral Shoulder Holder

Required Accessories

CamLoc Clamp: Order One

FACC0271

FACC920-0113 Disposable Hand/Forearm Wraps, Sterile, 12/cs



Wrist Tower

- Simply dial in your tension, eliminating sand bag use
- All components are autoclavable
- Easily attaches to side rail of surgical table w/ CamLoc Clamp (sold separately)
- Improves productivity, eliminating need for assistant to hold extremity

The Wrist Traction Configuration offers a variety of positioning capabilities. You can apply traction by simply dialing the knob from 0-25 lbs (0-11 kgs). Pronation and Supination can be easily controlled by the surgeon's preference and locked in place.

FACC0167 Wrist Tower

Required Accessory: Order One

CamLoc Clamp

FACC0271

Optional Accessory

FACC355 XS Finger Traps, Limited Reuse

FACC356 S Finger Traps, Limited Reuse

FACC357 M Finger Traps, Limited Reuse

FACC358 L Finger Traps, Limited Reuse

FACC359 XL Finger Traps, Limited Reuse

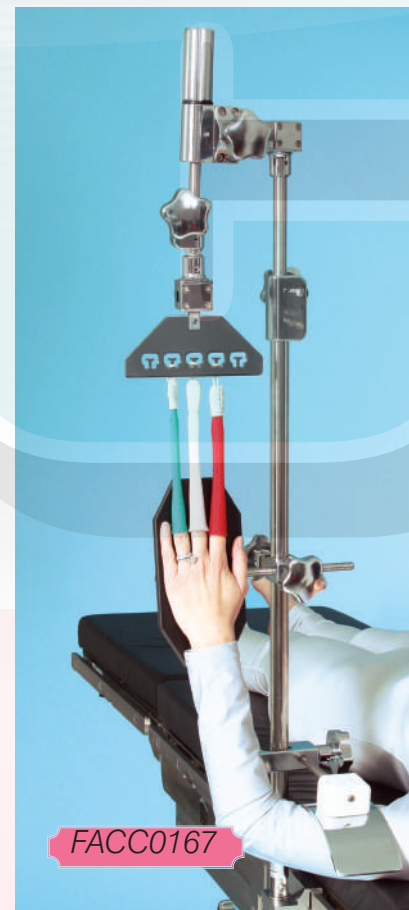

Surgical Table Accessories

End Rest Procedure Table

Choose Carbon Fiber or Phenolic

- Easy-to-use durable surgical table
- Carbon fiber technology produces incredibly solid components that are completely invisible to x-rays
- Adjusts up or down to be level with the OR table
- End rail accommodates traction attachment and locks to side rail in seconds
- Adjustable leg height with twist handle locking system

Table measures 16"W (41cm) at narrow end and 34"L x 26" (86cm x 66cm) at wider end. Deluxe foam pad included.



Hourglass Procedure Table

Choose Carbon Fiber or Phenolic

- Easy-to-use durable surgical table
- Carbon fiber technology produces incredibly solid components that are completely invisible to x-rays
- Adjusts up or down to be level with the OR table
- End rail accommodates traction attachment and locks to side rail in seconds
- Adjustable leg height with twist handle locking system

Table measures 15"W (38cm) at middle and 32"L x 23"W (84cm x 58cm) at table ends. Deluxe foam pad included.



Ordering Information

End Rest Major Procedure Table

FACC323 End Rest Major Procedure Table, Carbon Fiber
FACC325 End Rest Major Procedure Table, Phenolic
FACC508-0101 Replacement Deluxe Foam Pad

Hourglass Major Procedure Table

FACC326 Hourglass Major Procedure Table, Carbon Fiber
FACC320/FACC321 Hourglass Major Procedure Table, Phenolic
FACC508-0106 Replacement Deluxe Foam Pad

Two Clamps Required for
Either Product: Order Two

Universal Clamp
FACC0012

Deluxe Rail Clamp
FACC0023

Surgical Table Accessories

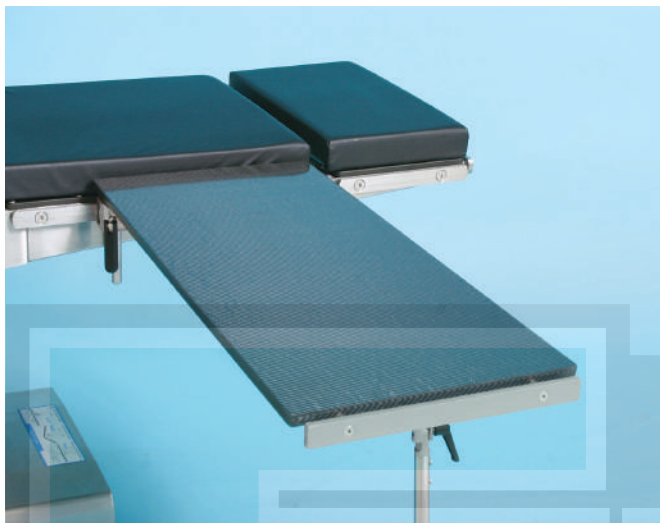

Major Procedure Table

Choose Carbon Fiber or Phenolic

- Easy-to-use durable surgical table
- Carbon fiber technology produces incredibly solid components that are completely invisible to x-rays
- Adjusts up or down to be level with the OR table
- End rail accommodates traction attachment and locks to side rail in seconds
- Adjustable leg height with twist handle locking system

Table measures 15"W x 34"L (38cm x 86cm).
Deluxe foam pad included.

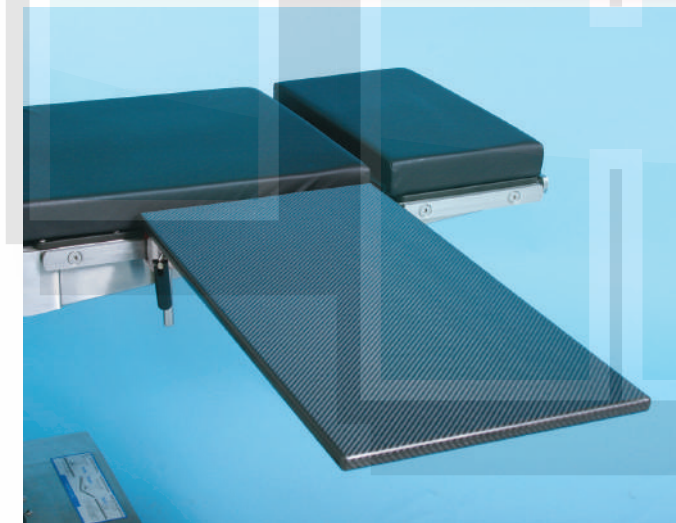

Minor Procedure Table

Choose Carbon Fiber or Phenolic

- Easy-to-use durable surgical table
- Carbon fiber technology produces incredibly solid components that are completely invisible to x-rays
- Adjusts up or down to be level with the OR table
- Perfect for all arm and hand procedures
- No leg attachment

Table measures 15"W x 30"L (38cm x 76cm).
Deluxe foam pad included.

Ordering Information

Rectangle Major Procedure Table

FACC316 Rectangle Major Procedure Table, Carbon Fiber
FACC310 Rectangle Major Procedure Table, Phenolic
FACC508-0073 Replacement Deluxe Foam Pad

Rectangle Minor Procedure Table

FACC331 Rectangle Minor Procedure Table, Carbon Fiber
FACC330 Rectangle Minor Procedure Table, Phenolic
FACC508-0072 Replacement Deluxe Foam Pad

Two Clamps Required for
Either Product: Order Two

Universal Clamp
FACC0012

Deluxe Rail Clamp
FACC0023

Surgical Table Accessories

Standard Armboard

- Simply place armboard on OR table side rail and it snaps locked tight
- Armboard offers a full range of motion, swings 180°
- Simply pull finger trigger at end of armboard and move to required position. Release trigger and it locks tight. To remove, just pull finger trigger and lift off side rail.

Armboard, Standard
FACC0024

BB2080AP-2D 2" (5cm) Deluxe Pad
BB2080AP-25F 2" (5cm) Softcare Pad

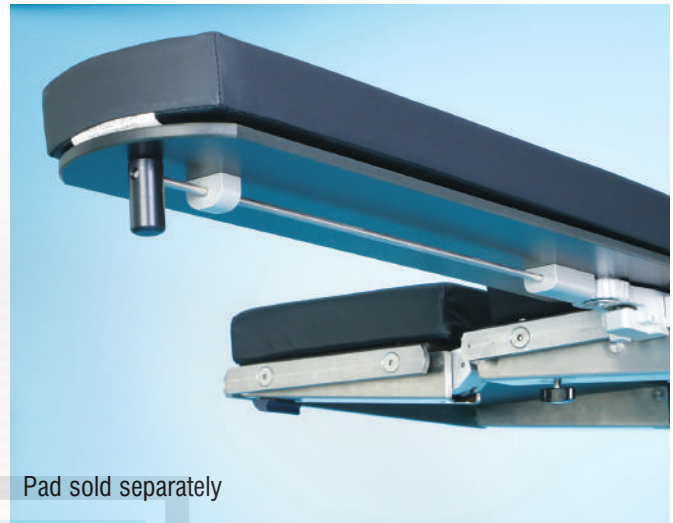

Pad sold separately

Adjustable Height Armboard

- This armboard adjusts vertically to be level with OR table, either with or without X-ray tops
- To adjust armboard vertically, simply place armboard on side rail, loosen handle and raise to correct table height and tighten handle
- Eliminates multiple size pads

Armboard, Adjustable
FACC0026

BB2080AP-2D 2" (5cm) Deluxe Pad
BB2080AP-25F 2" (5cm) Softcare Pad

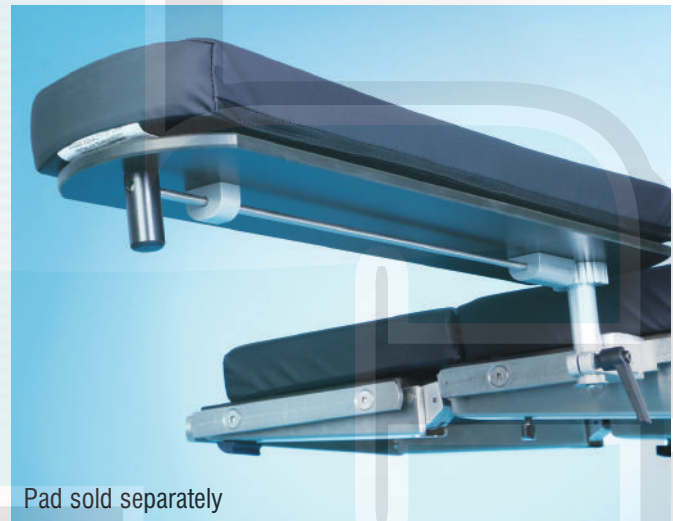

Pad sold separately

Extra-Wide Armboard

Armboard, Extra-Wide

- 11"W x 26 $\frac{1}{2}$ "L (28cm x 67cm) to offer a bigger surface area when necessary

FACC0027

Armboard, Extra-Wide, Adjustable

- This armboard adjusts vertically to be level with OR table, either with or without X-ray tops

FACC0037

FACC508-0105 2" (5cm) Deluxe Pad
FACC508-0152 2" (5cm) Softcare Pad



Pad sold separately

Surgical Table Accessories



Radiolucent Armboard

- Slips under patient's shoulder and provides support during injection of contrast materials for MRI and CT scans or placement of PICC lines
- 2" conductive, vinyl-covered foam pad mounts with an attached sleeve and strap (sold separately)
- Radiolucent, Phenolic and Reusable

FACC0038 Armboard, Radiolucent, 6"W x 3"L

BB2080AP-2D 2" (5cm) Deluxe Pad

BB2080AP-25F 2" (5cm) Softcare Pad

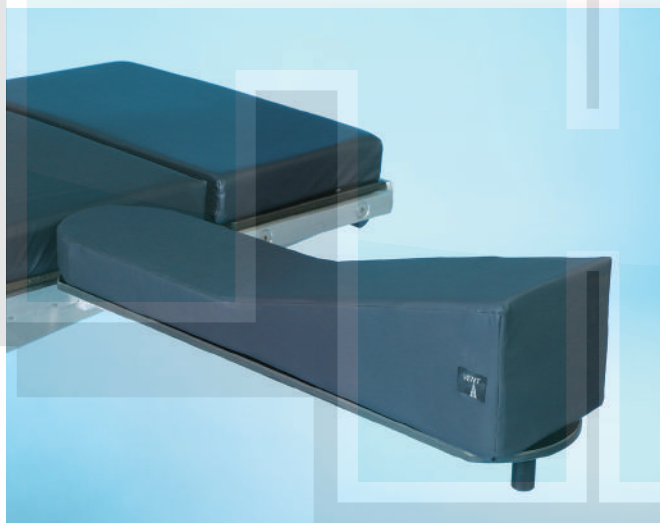

Incline Armboard Pad

- Prevents hyperextension of the forearm
- Fits all 6"W x 26"L (15cm x 66cm) armboards
- Made with pressure-diffusing T-Foam™
- Covered in durable, black, conductive vinyl

FACC0056 Armboard, Incline Pad



Armboard Holder

- Stores two standard surgical table armboards
- Use convenient top shelf for clamps or other accessories
- Attaches to wall with four screws (supplied)

FACC0039 Armboard Holder

Surgical Table Accessories

FACC0100



FHC Spine Frame

- Adjusts intraoperatively to the desired lordosis to get optimal surgical site exposure
- Optional transport dolly available
- Patient weight capacity is 500 lbs (227 kgs)
- Deluxe foam pads included

The FHC Spine Frame provides a stable and convenient platform for spine surgeries such as laminectomies, decompressions, and disc surgery. You can adjust it intraoperatively to the desired lordosis to get optimal surgical site exposure. Tapered adjustable pads provide optimal patient safety and comfort. The FHC Spine Frame has a patient weight capacity of 500 lbs (227 kgs) and is C-arm compatible. It can be used with any OR table, and fits the Jackson Spine Table and Allen Flex Frame as well. Comes with crank handle, disposable head rest, and two arm cradles. Optional dolly is available

FACC0100 Schure Spine Frame

Optional Accessories

- | | |
|--------------|---|
| FACC508-0373 | Disposable Laminectomy Arm Cradles, 12 prs/cs |
| FACC508-1340 | Disposable Richard Slotted Head Rests, Extended, 6/cs |
| FACC508-0472 | FHC Spine Frame Pad Set |
| FACC0105 | FHC Spine Frame Crank Handle |
| FACC0106 | Dolly, FHC Spine Frame |

Surgical Table Accessories

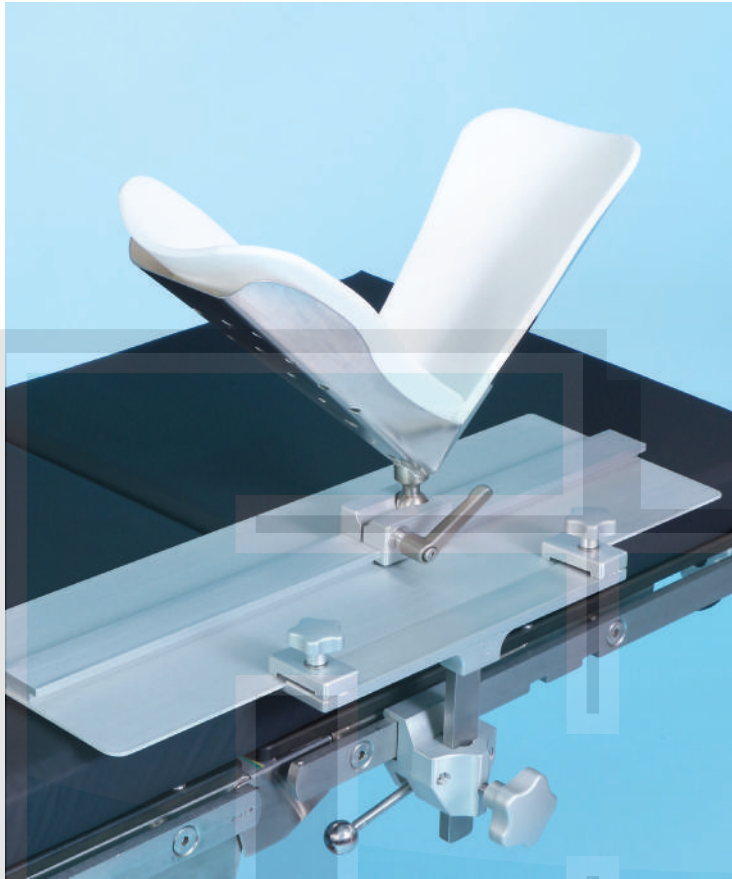

TKR Positioner for Total Knee Replacement

- Track Locking Bracket securely locks the Base Plate to the table with two thumb screws
- Locks in any position with a simple turn of the wrist
- Smooth sliding motion for effortless leg positioning
- All components are autoclavable
- CamLoc Clamp sold separately (see below)

Ball joint allows the surgeon to position the operative leg in extension, flexion, tilt and rotation.

FACC0141 TKR Positioner, 24" (61cm)

FACC0171 TKR Positioner, 30" (76cm)

FACC0146 Disposable TKR Boot Liners, Sterile, 12/cs

Required Accessory: Choose One
CamLoc Clamp
FACC0271



Stainless Steel

Schure Foot for Total Knee Replacement

- This new design offers the same secure support as the stainless steel model without the concerns of radiopacity
- The surgeon can replace the knee while the patient's foot is held firmly in place
- Disposable conductive, non-latex foot pad included
- Now available in radiolucent, clear Lexan®
- Patient's well leg lies flat
- Schure Socket XL sold separately

FACC0133 Schure Foot, Lexan

FACC333 Schure Foot, Stainless Steel

FACC508-0111 Disposable Foot Pads, 12/cs

FACCF-RCP2 Schure Socket XL



Lexan

Surgical Table Accessories

Arthroscopic Leg Holder

- VELCRO® brand fastener strap wraps completely over leg holder for total stability
- Pressure relief foam pad included
- (2cm) $\frac{5}{8}$ " mounting post
- Schure Socket XL sold separately
- Extremely versatile, easy-to-use and completely rigid.
Spring-loaded braces slide into place and snap lock.

FACC0080 Arthroscopic Leg Holder

FACC508-0103 Disposable Premium Pads, 12/cs

FACCF-RCP2 Schure Socket XL

FACC2250 Well Leg Holder



Schure Grip Leg Holder

- Dual independent braces freely rotate 360° and spread horizontally from 3"-11"W (8cm-28cm) to fit any size leg at any angle
- Twist one brace side down, put the patient's leg on the leg holder, return the brace side back up, slide brace horizontally for a snug fit, and lock in place with convenient twist handle

Use also for ACL procedures. Stainless steel. 12"L x 1½"D (31cm x 4cm) leg support x 8"H (20cm) braces, 16"H x $\frac{5}{8}$ "D (41cm x 1.6cm) mounting post. Schure Socket XL sold separately.

FACC0057 Schure Grip Leg Holder

FACC508-0103 Disposable Premium Pads, 12/cs

FACCF-RCP2 Schure Socket XL

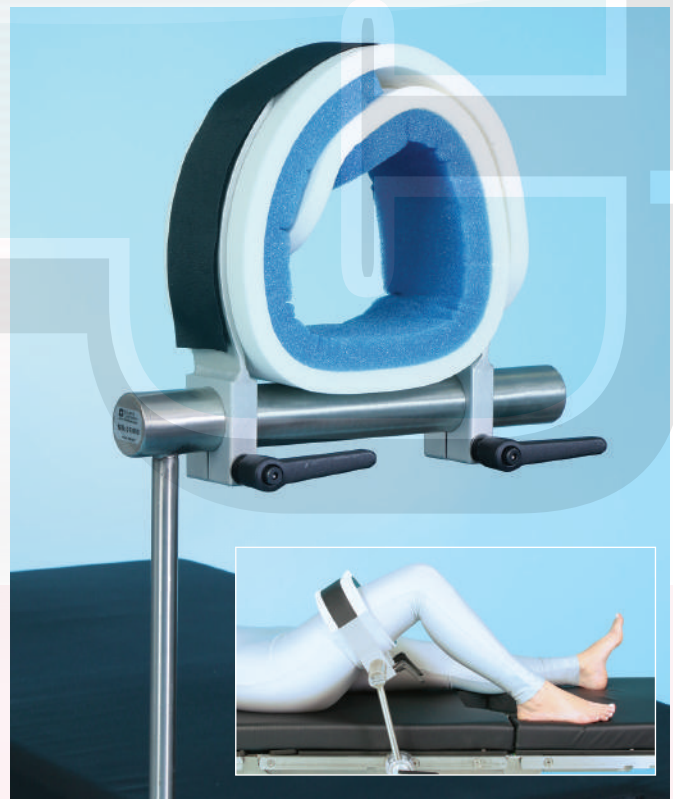

Surgical Table Accessories



Foot Extension

- Mounts vertically as a foot support when using reverse Trendelenburg
- Fits all OR tables and completely radiolucent

Use as a table extension in the horizontal position to lengthen size of OR table. 2" (5cm) Deluxe Pad included.

FACC0022 Foot Extension, 20"W x 10"L (51cm x 25cm)

Required Simple Clamp: Order Two FAC0003

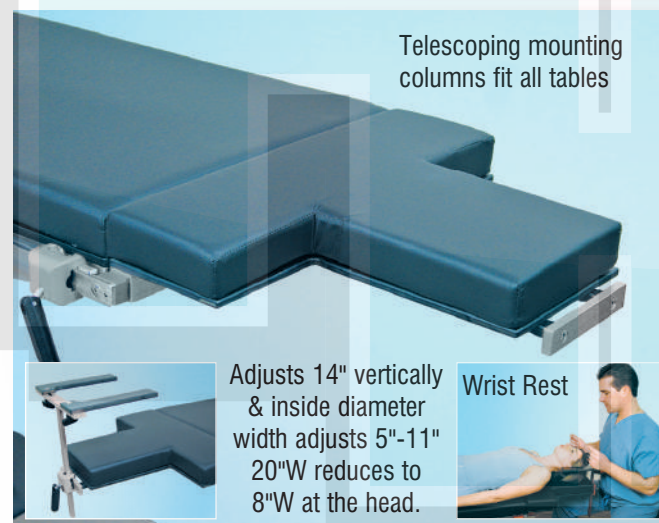

Narrow Head Rest

- Improves surgeon's access at the head of the surgical table during ENT, neurosurgery, plastic surgery or ophthalmic surgery. Use instead of standard head rest.
- Radiolucent head rest includes 2" (5cm) premium pressure management pad. Deluxe pad included.

FACC0062 Narrow Head Rest

Required Simple Clamp: Order Two FAC0003

Optional Accessory FACC0067 Wrist Rest

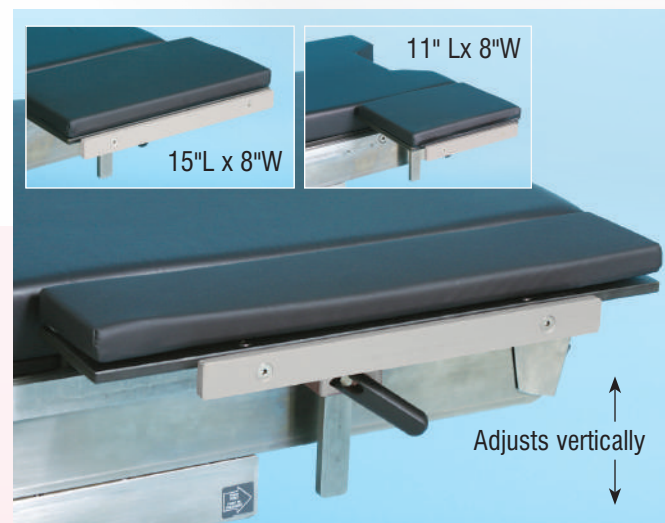

Table Width Extenders

- Attaches to OR side rail with mounting clamp
- Raise or lower height of extender to be level with the OR table, either with or without an x-ray top

Attached side rail allows any table accessory to be mounted. Deluxe pad included.

FACC0077 20"L x 4"W (51cm x 10cm)
 FACC0067 15"L x 8"W (38cm x 20cm)
 FACC0068 11"L x 8"W (28cm x 20cm)

Required Simple Clamp: Order One FAC0003

Surgical Table Accessories

Shoulder Supports

- Provides comfortable support for Trendelenburg positioning
- Deluxe pads on a broad support surface with ball and socket adjustments provide optimal positioning for any size patient
- Adjusts vertically to accommodate x-ray tops
- Schure Socket XL sold separately

FACC63500 Shoulder Supports

Required Accessory
FACCF-RCP2 Schure Socket XL



Nissen Straps

- Offers support needed during steep reverse trendelenburg positioning. Attaches to rail quickly and securely.
- 20"L x 5"W x 1" (51cm x 13cm x 3cm) thick pad offers complete support

FACC0111 Nissen Straps, 48"L x 2"W
(19cm x 5 cm)

FACC0118 Bariatric Nissen Straps, 72"L x 2"W
(183cm x 5cm)

Required Simple Clamp: Order Two
FACC0003



Restraint Strap

- Amsco style
- All-rubber conductive strap
- 96"L (244cm) with two airplane-style buckles
- Very durable...easy to clean and disinfect
- Mounts to surgical table with or without hooks

FACC3200 Restraint Strap, No Hooks

FACC3250 Restraint Strap, 2 Hooks

FACC3300 Bariatric Restraint Strap, No Hooks

FACC3350 Bariatric Restraint Strap, w/Hooks



Surgical Table Accessories



Multi-Axis Arm Positioner

- Versatile and comfortable positioning with the new ball socket locking system
- Arm platform measures 6"W x 16"L (15cm x 41cm)
- 2" (5cm) Deluxe Concave Foam Pad included
- (2cm) $\frac{5}{8}$ " Mounting Post

Perfect for seated, lateral, prone, neuro and park bench positions. Schure Socket XL sold separately.

FACC0600 Multi-Axis Arm Positioner

FACCF-RCP2 Schure Socket XL



Lateral Positioners

- Lateral Positioners are simple to set up and offer another alternative for lateral positioning
- Three swivel braces have Deluxe foam pads and rotate over the OR to conform to any size patient, they offer complete stability and ease of use
- (2cm) $\frac{5}{8}$ " stainless steel mounting post
- Schure Socket XL separately

FACC0069 Lateral Positioners

FACCF-RCP2 Schure Socket XL



Lateral Braces

- Secure and comfortable positioning for total hip replacement, and any other procedure requiring total lateral stability
- Three multi-axis braces easily accommodate any size patient for perfect lateral positioning
- Pressure relief foam with Deluxe cover provide extreme protection for the patient
- Schure Socket XL sold separately

FACC6000 Lateral Braces

FACCF-RCP2 Schure Socket XL

Surgical Table Accessories

Toboggan Arm/Leg Guard

- Available in four sizes: Small through X-Large
- Simply slide under OR table pad to secure arms or legs
- Physician can lean against guards without interfering with anesthesia lines

FACC8001 Small, 6"H x 10"L (15cm x 25cm)

FACC8000 Medium, 8"H x 16"L (20cm x 41cm)

FACC8002 Large, 10½"H x 16"L (27cm x 41cm)

FACC8003 X-Large, 10½"H x 24"L (27cm x 61cm)



Anesthesia Screen

- Adjusts from 15"-33" (38cm x 84cm) in height
- Horizontal adjustment feature facilitates viewing of patient
- Locks with a .25" (.6cm) twist of the handle
- Stainless steel construction
- Schure Socket XL sold separately

FACC0005 Anesthesia Screen

FACCF-RCP2 Schure Socket XL



Winged Anesthesia Screen

- Holds surgical drape
- Can be adjusted to change height or angle
- Made of two anesthesia screens & lengthwise tube
- Composed of stainless steel
- Requires two Clark sockets on either side (sold separately)

FACC0007 Winged Anesthesia Screen

FACC0001 Clark crutch socket



Surgical Table Accessories

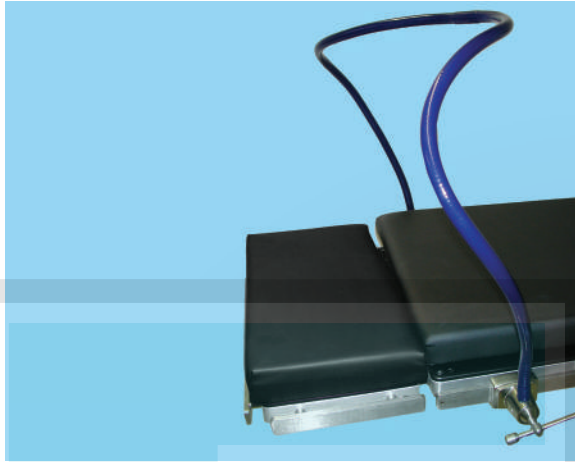

Malleable Anesthesia Screen

- Flexible, coated stainless steel tubing
- Easily shaped while retaining its memory,
- Allows for many different draping positions
- Rod ends attach to surgical table with two Clark sockets. (sold separately)

FACC0086 Malleable Anesthesia Screen

FACC0001 Clark crutch socket



Extremity Positioner

- Great for positioning the lower extremity for foot or ankle procedures
- Sealed seams for easy clean-up
- Dimensions: 16"L x 12"W x 7"H (41cm x 31cm x 18cm)

This pad is ideal and used regularly for prepping of the arm or leg surgical site.

FACC0357 Extremity Positioner



Saphenous Vein Harvest Pad

- Holds legs externally rotated and slightly flexed for minimally invasive, bridging or open harvesting procedures
- The cover is a multi-directional stretch cover. Inside consists of a top layer of conforming foam with a firm supportive base. Water-resistant cover is not made with natural rubber latex.
- Sealed watertight seams for easy clean-up

The Saphenous Vein Harvest Pad holds patient's legs at the optimal position for assessment and harvesting of the saphenous veins for coronary bypass surgery.

FACC0356 Saphenous Vein Harvest Pad

Surgical Table Accessories

Well Leg Holder

- Helps prevent nerve damage
- Works on both left and right leg

The foam Well-Leg Holder easily supports with comfort the non-affected, well-leg during arthroscopic knee procedures, fracture repairs and cast procedures.

FACC2250 Well Leg Holder



Universal Prepper

- Supports limbs of all sizes
- Pad removes for easy cleaning

The Universal Prepper safely and effectively holds upper or lower extremities. The unique pivoting design allows for infinite positioning of the extremity. Comes complete with 2" (5cm) thick Deluxe pad. Schure Socket XL sold separately.

FACC0161 Universal Prepper

FACCF-RCP2 Schure Socket XL



Elbow Arthroscopy Support

The Elbow Arthroscopy Support comfortably and securely holds the upper extremity for prepping and during surgical procedures. The unique pivoting design provides flexibility for all patient anatomies. Comes complete with Deluxe pad which can be removed for easy cleaning. Schure Socket XL sold separately.

FACC0168 Elbow Arthroscopy Support

FACCF-RCP2 Schure Socket XL



Surgical Table Accessories



Irrigation Towers

- Can hold up to eight (8), five (5) liter bags
- Wide, inverted, 5-legged base resists tipping...no need for “sand-bagging”
- Adjustable from 5'- 8' (1.5m-2.4m) (9' with custom hangers)
- 2- or 4-channel designs
- Push-down squeeze release handles gives a 2-1 mechanical advantage
- No electric or hydraulic parts that require overnight recharging, heavy maintenance, or seals that leak

Great for fluid-intensive irrigation procedures such as arthroscopic, orthopedic, hysteroscopic, endoscopic, TURP, etc.

FACC0157 Irrigation Tower, 4-Channel

FACC0158 Irrigation Tower, 2-Channel



Safety Draw

- Avoid needle sticks
- Hands-free access to medication vials
- Easy viewing of medication labels
- Helps reduce medication errors

Safety-Draw maintains sterility while allowing access to non-sterile vials. This protects both patient and staff by helping to prevent dangerous medication mix-up, as well as needle sticks.

FACC0076 Safety Draw, IV Pole Mount

FACC0082 Safety Draw, Mayo Stand Mount

Surgical Table Accessories

Malleable Hand Positioner

- Case of 5
- Made with aluminum
- Perfect for micro nerve reconstruction procedures
- Can withstand more than 20 articulations
- Two sizes available
- Fits almost any surgical patient
- Autoclavable
- Radiolucent

FACCA20900 Malleable Hand Positioner



Equalizing Device

- Provides equal traction to all 5 fingers
- Used w/ Mesh Finger Traps or S/S Finger Traps
- Autoclavable

FACCR734-05 Equalizing Device

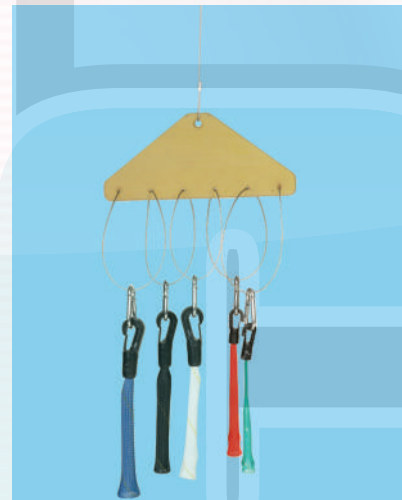

Mesh Finger Traps

- Latex-free
- Double-sleeved soft mesh material
- Firmly grips fingers & hands to provide a comfortable, custom fit to each traction procedure
- Can be purchased sterile or non-sterile

FACC355 - XS
FACC356 - S
FACC357 - M
FACC358 - L
FACC359 - XL



Surgical Table Accessories



Schlein Hand Positioner

- Supports multiple positions
- Innovative cleat system can be used with or without weights
- Autoclavable

FACCA20750 Schlein Hand Positioner



FHC1000 Orthopedic Extension

- Complete set of orthopedic accessories for use with the FHC1000 series
- Carbon fiber abductor bars rested on cart during insertion onto side rails of seat section
- Includes full range of accessories for lower limb traction

FACC0061 FHC1000 Orthopedic Extension

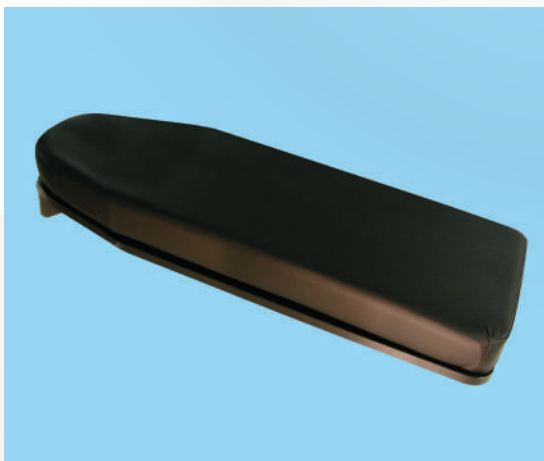

Wide Armboard

- Includes 2" pad
- Measures: 11"W x 26"L
- Rotates 180°
- 21 locking increments
- Compatible with 1,2,3 & 4" pads
- Fits all major surgical tables

FACC4410 Wide Armboard

Surgical Table Accessories

Horseshoe Headrest

- Includes traction bar
- Connects to surgical table using multi-positioning base & swivel adapter
- Support prone or supine positioning
- Easily adjusted for various patient head sizes
- Includes swivel adapter (FACC0101)
- Gel pads can be removed to leave unit for efficient cleaning (autoclavable)
- Compatible with the FHC1000 series surgical tables

FACC0103 Horseshoe Headrest w/ Traction Bar



Lateral Support

- Attaches anywhere along side rails
- Provides patient with lateral support
- Includes 2 adjustable joint to fit patient size & position
- Made of stainless steel and integrated polyurethane foam pad
- Requires a side rail lock to be secured

FACC0015 Lateral Support

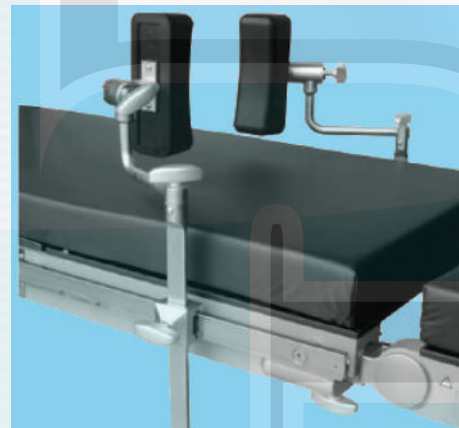

Cassette Top for FHC1000 Series

- Attaches to top of O.R. table
- Allows convenient lateral insertion of x-ray cassettes

FACC0046 Cassette Top for FHC1000 Series Surgical Table

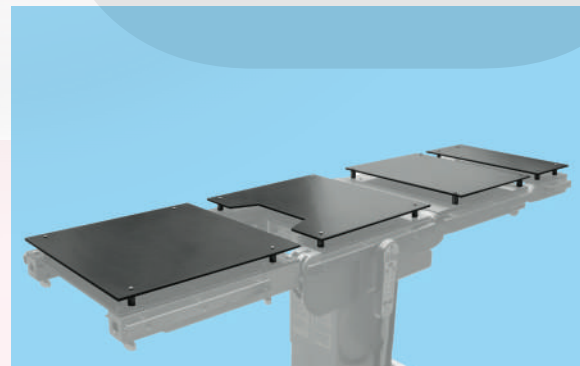

Surgical Table Accessories



Alero Deluxe Armboard Restraint Strap

- Two part strap w/ double velcro closures
- Attaches to arm board for easy use
- Upper strap - 26"L x 2"W
- Lower strap - secures around 6" boards

FACC4000 Alero Deluxe Armboard Restraint Strap

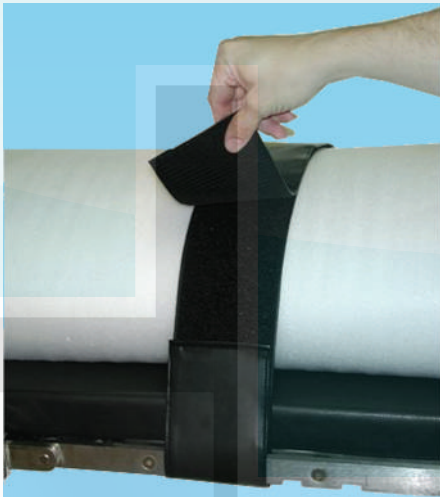

Deluxe Two-Piece Vinyl/Velcro Restraint Strap

- 4" wide
- Secures to side rails
- No hooks required
- Extends 30" to 70"

FACC3400 Deluxe Two-Piece Vinyl/Velcro Restraint Strap



Counter-Traction Strap

- Supports patient while being manipulated during surgery
- Attaches to surgical table using clare socket (FACC0001 - sold separately)

FACC0079 Counter-Traction Strap

Surgical Table Accessories

Universal Well Leg Support

- Solid stainless steel adjustable extension bar
- Boot clamp is designed for full-range positioning
- Ideal for positioning patients of any height
- Comes with 1 Restraint Strap & 1 Pressure Management Pad
- Requires one Super clamp or clark socket for mounting to surgical table (sold separately)

FACC6610 Universal Well Leg Support (1ea.)



Picket Fence Leg Prep

- Efficiently preps both legs at once
- Stainless steel support bar - 5/8" diameter
- Height adjusts up to 30"
- Attaches to surgical table using a clark socket or Super clamp (sold separately)
- Easy positioning
- Easy cleaning

FACC4200 Picket Fence Leg Prep

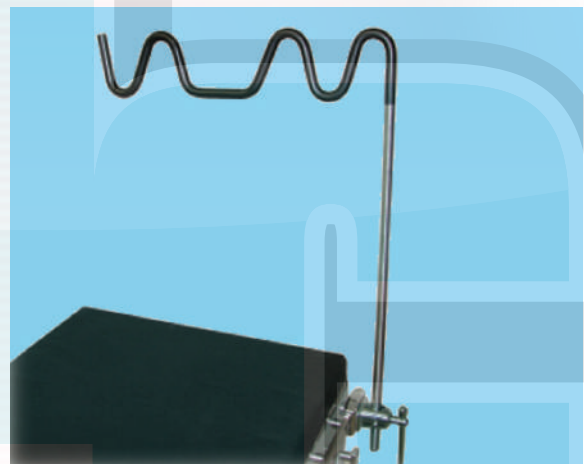

Leg Prepper

- Padded horseshoe cradle holds patient's leg comfortably during the prepping procedure
- Stainless steel 30"H x 5/8"D (76cm x 2cm) mounting post rotates, rises, and lowers easily to various prepping positions
- Schure Socket XL sold separately

FACC4800 Leg Prepper

FACC508-0107 Replacement Pad
FACCF-RCP2 Schure Socket XL



Surgical Table Accessories



Bi-Lateral Leg Prepper

- 500 lb (227 kg) patient weight capacity
- Pads remove for easy cleaning

The Bi-Lateral Leg Prepper safely and effectively holds both legs for bi-lateral preps. The unique rotating/pivoting design of the holders allow for infinite positioning off the extremity. Includes 2" (5cm) Deluxe Pads. Schure Socket XL sold separately.

FACC0236 Bi-Lateral Leg Prepper

FACCF-RCP2 Schure Socket XL

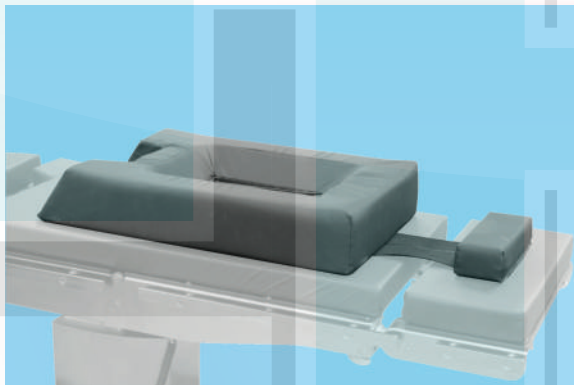

Dorsal Cushion

- Provides support during intravertebral disk operations
- Antibacterial
- Antistatic
- Flame-retardant
- Memory foam pad relieves pressure and prevents bedsores

FACC0028 Dorsal Cushion



Accessory Cart

- Stainless steel construction
- Rest on four swivel casters for easy movement
- Three stainless steel shelves
- Provides ample space for accessory storage
- Built-in clamps aid attachment of orthopedic abductor bars

FACC0063 Accessory Cart

Surgical Table Accessories

Plastic Drain Pan

- Collects liquid drainage during urological & gynecological procedures
- Attaches to bottom of either FHC1000 seat section or FACC0040 I.A. Extender

FACC0032 Plastic Drain Pan

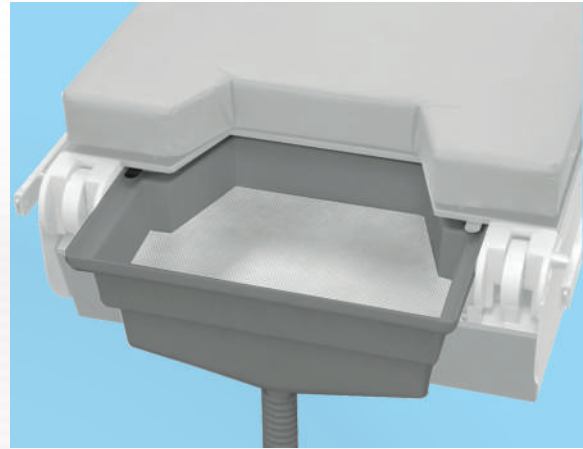

Deep Plastic Drain Pan

- Collects liquid drainage during urological & gynecological procedures
- Attaches to bottom of either FHC1000 seat section or FACC0040 I.A. Extender

FACC0033 Deep Plastic Drain Pan



Stainless Steel Drain Pan

- Collects liquid drainage during urological & gynecological procedures
- Attaches to bottom of either FHC1000 seat section or FACC0040 I.A. Extender

FACC0034 Stainless Steel Drain Pan

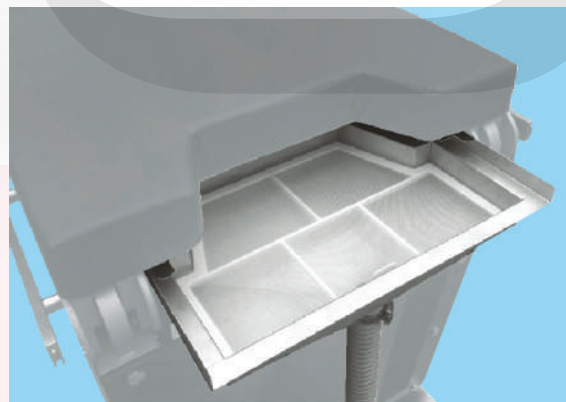

Surgical Table Accessories

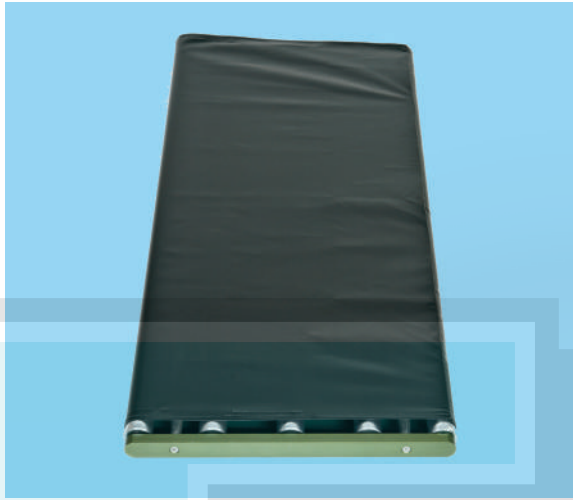

Patient Roller

- Assists with patient transfers
- Eliminates physical lifting of patients

Size Options:

FACC0123 - Patient Roller 25"L x 15"W
FACC0125 - Patient Roller 30"L X 15"W
FACC0126 - Patient Roller 30"L X 15"W
FACC0130 - Patient Roller 67"L x 15"W

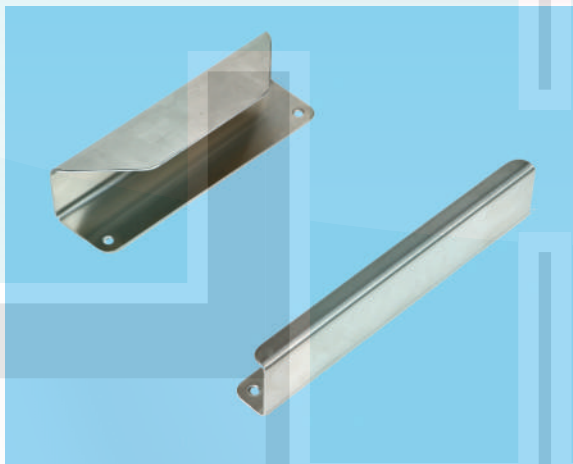

Stainless Steel Roller Board Holder

- Mounts easily on wall or door for convenient storage
- Fits roller boards made by almost all manufacturers

FACC0132 - Stainless Steel Roller Board Holder

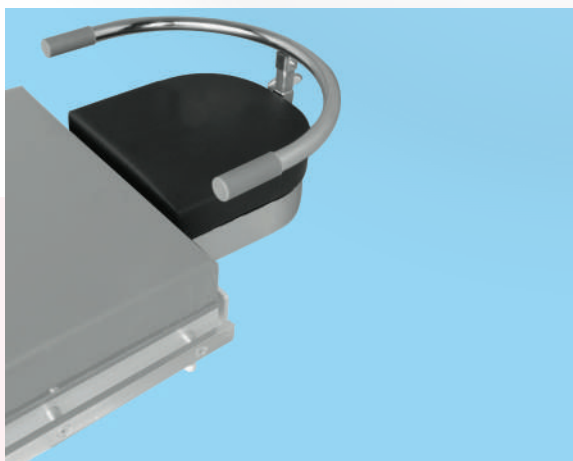

Ophthalmic Headrest with Surgeon Wrist Support

- Provides surgeon with full access to the facial region
- Wrist support bar helps prevent fatigue
- Comes with antibacterial, antistatic, flame-retardant pad
- Made with memory-foam to relieve pressure and prevent bedsores
- Has two bars used for insertion into the FHC1000 back section
- Structure is composed of stainless steel

FACC0036 Ophthalmic Headrest with Surgeon Wrist Support

Surgical Table Accessories

ENT Headrest

- Constructed specifically for ENT procedures
- 2" thick pad
- Attaches to FHC1000 surgical table

FACC0062 ENT Headrest



Adjustable Headrest Adapter

- Provides adjustable insertion points for DORO® and other neurosurgery headsets
- Installed onto the back section, in both normal and reverse orientation
- Composed of stainless steel

FACC0035 Adjustable Headrest Adapter

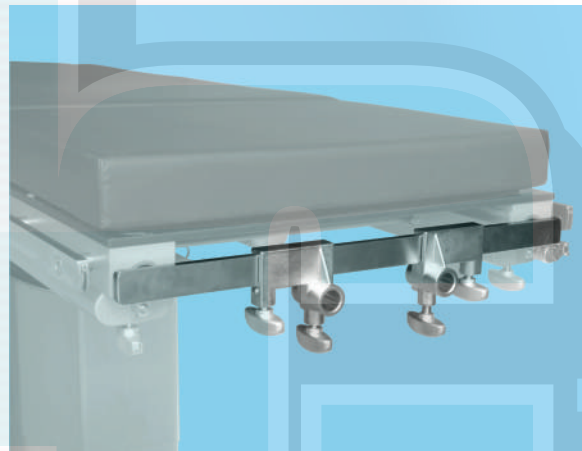

Uro Extender

- Useful in urology and procedures which require ample IA coverage
- In normal orientation it can be attached to the seat section
- Reverse orientation it can be attached to the back section
- Includes a perineal cutout, and 2 ½ in (6.3 cm) thick pad
- Has insertion points which are identical to those of the table
- Made with radiolucent phenolic board

FACC0040 Uro Extender

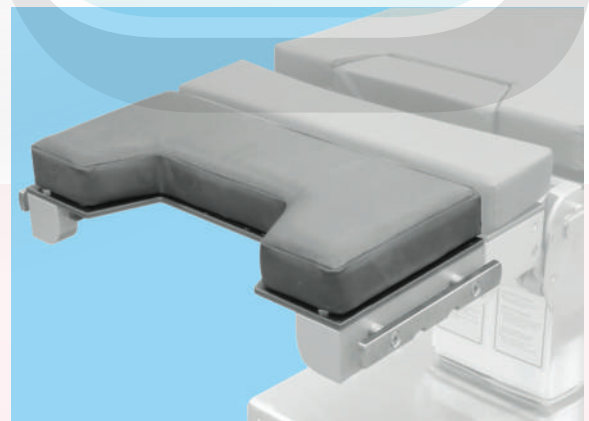

Surgical Table Accessories

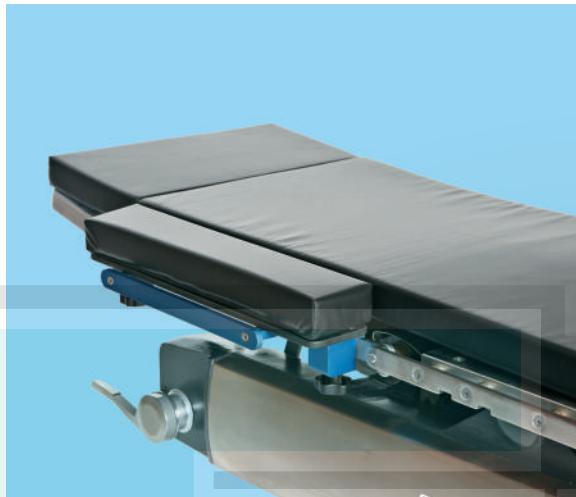

Long Table Width Extender

- For use with bariatric patients
- Extends the width of the table top by 4" (45 cm long)
- Attaches to the back, seat or leg section using an integrated clamp
- Comes with antibacterial, antistatic, flame-retardant pad
- Made with memory-foam to relieve pressure and prevent bedsores.

FACC405 Long Table Width Extender

FACC404 Replacement pad



Foot Controller

- Provides surgeon with the capability to move the table when using the hand pendant is inconvenient.
- Communicates with 3 meter long cord
- Used to control height, Trendelenburg, reverse Trendelenburg & lateral tilt functions
- Foot controller meets fluid ingress protection of IPX-7

FACC0045 Foot Controller



Infusion Stand

- Fastened to the side rail using a Clark socket
- Height and angle can be adjusted manually
- Composed of stainless steel & plastic

FACC0008 Infusion Stand

Surgical Table Accessories

Morgan Pelvic Rest

- Support bar covered in cylindrical pad
- Provides pelvic support during rectal procedures
- Comes with antibacterial, antistatic, flame-retardant pad
- Made with memory foam to relieve pressure and prevent bed-sores
- Attaches to the surgical table side rails using two Clark Sockets
- Structure is composed of stainless steel

FACC0029 Morgan Pelvic Rest

FCP001559 Replacement pad



Horizontal Traction Tower

- Solid stainless steel construction
- Adapts easily to end of most arm & hand tables
- 3/4" outside diameter
- Square tube with 1/2" telescoping tube
- Comes complete with all necessary hardware

FACC344 18" long for rectangular-shaped table

FACC345 24" long for hourglass-shaped table



Radiolucent Armboard w/ Enhanced Post-Loc Rail Mounting System

- Built-in mounting mechanism allows for easy vertical up & down movement
- Adjusts to level for O.R. table surface without changing arm board pad
- Easy 180° rotation when mounted on either side of O.R. table
- Secure positive locking mechanism for safe & easy fit to any O.R. table rail
- Lever-free arm board provides no interface during C-arm imaging and x-ray procedures
- Measurements: 6"W x 26" L

FACC0401 Radiolucent Armboard w/ Enhanced Post-Loc Rail Mounting System



Surgical Table Accessories

Arthroscopic Stress Post



- Provides fulcrum to leverage the leg for better knee access
- 5/8" diameter
- Height adjustable post
- Includes: 4" x 6" pad
- Stainless steel plate & support bar
- Available in 12" or 18" post height
- Securely attaches to any O.R. table using Clark socket

FACC9050-12 Arthroscopic Stress Post w/ 12" Height
FACC9050-18 Arthroscopic Stress Post w/ 18" Height

Transfer Board

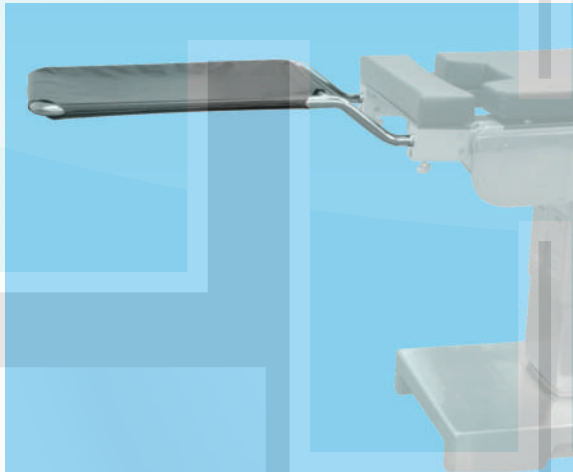

- Helps attach accessories with flat bar sizes 1/4" x 1"
- Tightened using a thumb screw
- Composed of stainless steel

FACC0041 Transfer Board

Arm Traction Device

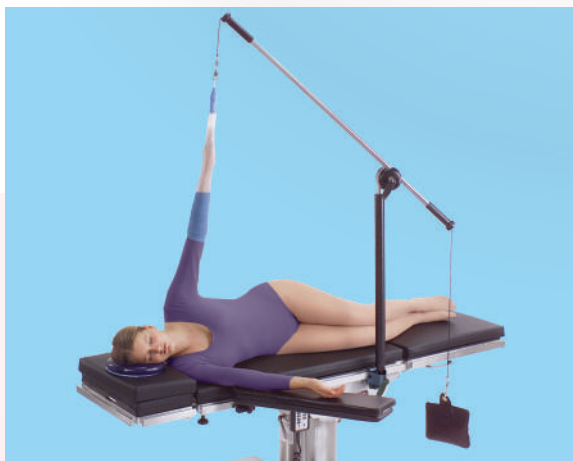

- Accommodates intraoperative traction up to 40 lbs for shoulder, arm, and wrists procedures
- Mechanical safety stop prevents patient injury
- Saves time by using arm support for prep and traction

FACC20500 Arm Traction Device

Surgical Table Accessories

Duraclear Arm & Hand Tables

- Provides excellent X-ray clarity
- C-Arm visualization
- 3 sizes available
- Comes with 1" standard pad
- Requires 2 clark sockets or round bar clamps (for mounting)
- Fits all North American surgical tables

FACC1200 12"x30" Duraclear™ Table w/ Pad

FACC1600 16"x30" Duraclear™ Table w/ Pad

FACC1800 18"x30" Duraclear™ Table w/ Pad

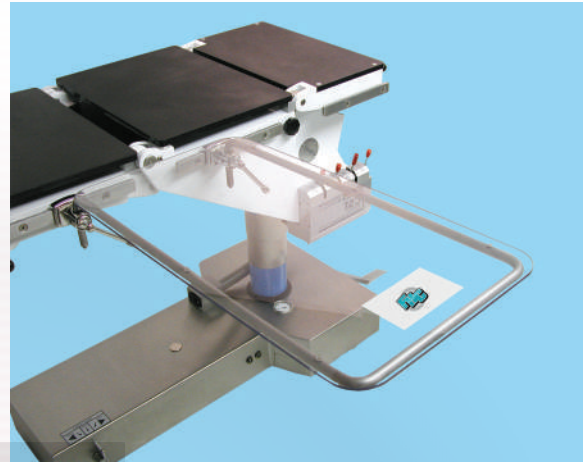

LPS Arm Support

- Provides comfortable & convenient placement of non-operative arm
- Easy access to patient I.V.
- Enhanced stabilization of shoulder
- Attaches to the surgical table using a Clark Socket

FACC0078 LPS Arm Support



Under Pad Mount Arm & Hand Tables

- Very durable table
- Offers poly carbonate covered opening (14"W x 24"L) for C-arm access
- Rugged stainless steel construction
- Designed to slip under pad
- Convenient handle to carry/store table easily
- Optional Add-A-Rail easily added to end of board for multiple accessories

FACC341 Under Pad Mount Arm & Hand Tables

FACCM312 - replacement 2" thick pad only



Surgical Table Accessories

Kross Arm Support



- Perfect for arm chair, prone, lateral, & neuro procedure positioning
- SS arm cradle measures 6" x 20"
- Disposable Kross Kloth sleeve
- Includes: 1 roll
- Requires: 1 Clark Socket for mounting (sold separately)

FACC7500 Kross Arm Support

FACC7520 - Disposable Kross Kloth

Split Leg Section For FHC1000 O.R. Tables

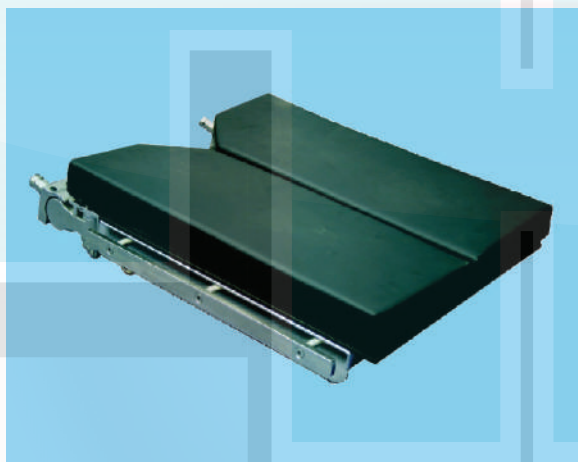

- Manually operated
- Can be raised 30°, lowered 90°, & opened 180°
- Each leg plate includes it's own antibacterial, antistatic, flame retardant memory-foam mattress pad
- Weight capacity of 800 lbs.

FACC0092 Split Leg Section For FHC1000 O.R. Tables

Add-A-Rail



- Solid stainless steel
- Mounts to block underneath table w/ 2 counter sunk screws
- Allows you to adapt multiple accessories at one time

FACC314 18" long for rectangle-shaped table

FACC324 24" long for hourglass-shaped table

Surgical Table Accessories

FHC Strap VELCRO® Rolls

FHC Strap is the answer to your taping, strapping, tie-down and restraining requirements. It has VELCRO® brand fastener hook and loop back-to-back on 30' (9 meters) rolls and available in 4 widths. No sticky tape residue to damage equipment. Soft edge design to protect patient's skin. Not made with natural rubber latex.

FACC0147	3/4"W (2cm)
FACC0148	1 1/2"W (4cm)
FACC0149	3"W (8cm)
FACC0150	5"W (13cm)



A-Line Positioner w/Straps

A-Line Positioner w/Straps consist of two exclusive 1"W x 17"L (3cm x 43cm) soft edge straps which reduce the risk against skin ulceration. This anatomically formed base provides the best angle while keeping the skin taut for optimal needle insertion.

FACC0143	Disposable A-Line Positioner w/Straps, 12/cs
----------	--



A-Line Positioners

- Stable and accurate positioning
- Enhanced comfort for the patient
- No need to try to find a make-shift positioner
- Has slot to secure to armboard

Disposable support positioner to provide for a fast, consistent and reliable A-Line insertion.

FACC0144	Disposable A-Line Positioners, 30/cs
----------	--------------------------------------



Surgical Table Accessories



Comfort Mat

The 20" x 33" (51cm x 84cm) Comfort Mat is ideal at scrub sinks, nurse's stations or at OR tables. Helps reduce fatigue, pain and discomfort associated with standing for long periods of time.

- Absorbent-resistant closed-cell foam
- Beveled, low-profile edges
- Non-slip surface is chemical resistant
- Custom sizes are available

FACC0145 Comfort Mat



Schure Slide,
Full-Size

Schure Slide, Ergo

Schure Slide,
Anti-Static

SCHURE SLIDE
patient transfer systems

Schure Slide is smooth surfaced, flexible, and extremely durable. After being placed under a patient, personnel can effortlessly slide the patient from one gurney or table to another. The Full-Size Schure Slide enables personnel to easily slide the patient from one bed to another. Choose Flexible or Rigid. Patented.

- Reduce back injuries and increase comfort
- Non-disposable, no need to waste red bags
- Won't stain—spray and wipe clean
- Speed up turnover time—hang Schure Slide in every OR
- Radiolucent & not made w/ natural rubber latex

ORDERING INFORMATION

FACC2200	Schure Slide, XL, 33"L x 22"W x 1/16"
FACC2201	Schure Slide, Rigid, 33"L x 22"W x 3/16"
FACC2202	Schure Slide, Ergo, 33"L x 23"W x 1/16" 1/16"
FACC2203	Schure Slide, Anti-Static, Black, 33"L x 22"W x 1/16"
FACC2204	Schure Slide, Anti-Static Rigid, Black, 33"L x 22"W x 3/16"
FACC2205	Schure Slide, Full Size, 72"L x 22"W x 3/16"
FACC2206	Schure Slide, Full Size, Anti-Static, Black, 72"L x 22"W x 3/16"
FACC2207	Schure Slide, XLT, 72"L x 22"W x 3/16"

Surgical Table Accessories

800 lb. (363 kg)
Patient Wt. Capacity



Patented

Schure Socket XL

- Hardened clamping surface creates maximum clamping force stopping movement of all accessories
- Attaches along the side rail, without the need of notches

Accepts any round mounting posts up to $\frac{5}{8}$ "D (1.6cm) and rectangular mounting posts up to $1" \times \frac{3}{8}"$ (2.5cm x .95cm). Quickly and easily connects and disconnects securely with a quick turn anywhere along the side rail, even over side rail stand off.

Schure Socket XL
FACCF-RCP2

800 lb. (363 kg)
Patient Wt. Capacity

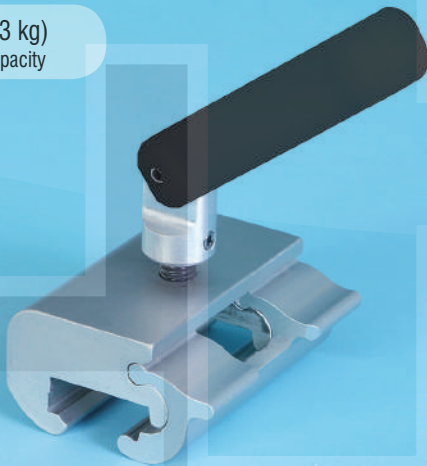

SpringLoc Clamp

- Securely locks accessories with a flat $1" \times \frac{1}{4}"$ (2.5cm x .6cm) mounting post
- Attaches along the side rail, without the need of notches
- Quick & easy pull-to-release lever

FACC0011 SpringLoc Clamp

800 lb. (363 kg)
Patient Wt. Capacity

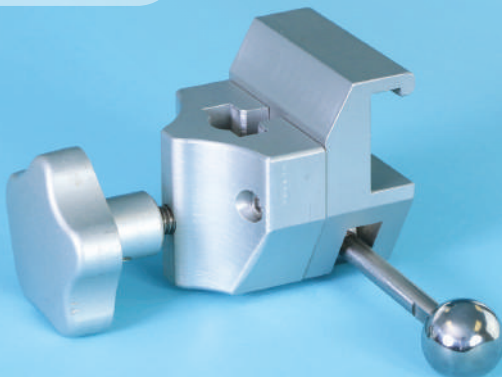

CamLoc Clamp

- It can attach to the rail at any location over multiple drapes and accepts accessories with round posts up to $\frac{5}{8}$ "D (1.6cm) and flat posts $1" \times \frac{3}{8}"$ (2.5cm x .95cm)
- Attaches along the side rail, without the need of notches

The CamLoc Clamp is fully autoclavable and is designed for use in the sterile field.

CamLoc Clamp
FACC0271

Surgical Table Accessories

Schure Socket

- Fits round mounting posts up to $\frac{5}{8}$ "D (2cm)
- Locks securely with a twist of the ergonomic handle
- Attaches along the side rail, without the need of notches

The industrial strength Schure Socket fits all OR tables with standard $\frac{3}{8}$ "W x $1\frac{1}{8}$ "H (.95cm x 2.85cm) side rails.

FACC0084



Universal Rail Clamp

- Spring-loaded and attaches to OR table side rail anywhere along the rail
- Accessories can be mounted vertically or horizontally
- Locks securely with a twist of the ergonomic handle

Accepts both $\frac{5}{8}$ "D (1.6cm) and $1" \times \frac{3}{8}"$ (2.5cm x .95cm) flat bar mounting posts.

FACC0012 Universal Rail Clamp



Simple Clamp

- Attaches at OR table rail ends or notches
- Accessories can be mounted vertically or horizontally

Securely locks all accessories with flat $1" \times \frac{3}{8}"$ (2.5cm x .95cm) mounting blades anywhere along the table side rail.

FACC0003

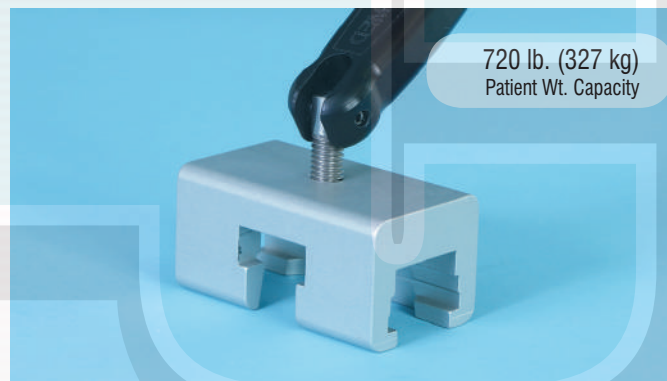

Deluxe Rail Clamp

- Attaches at OR table rail ends or notches
- Accessories can be mounted vertically or horizontally

Securely locks all accessories with $1" \times \frac{3}{8}"$ (2.5cm x .95cm) flat mounting post and round mounting posts up to $\frac{5}{8}$ "D (1.6cm) mounting blades anywhere along the table side rail.

FACC0023



Surgical Table Accessories



Clarke Crutch Socket

- Hardened clamping surface creates maximum clamping force stopping movement of all accessories
- Attaches along the side rail, without the need of notches

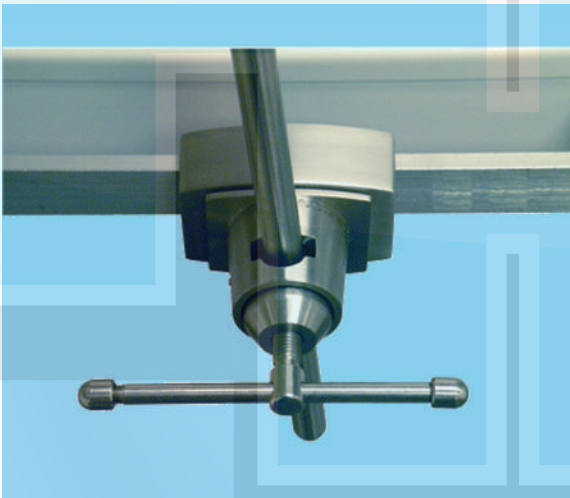

Ultra Clarke Socket

- Securely locks accessories with a flat 1" x 1/4" (2.5cm x .6cm) mounting post
- Attaches along the side rail, without the need of notches
- Quick & easy pull-to-release lever

FACC0011 SpringLoc Clamp



Straight Bar Accessory Clamp

- Solid stainless steel construction
- Accommodates all rectangle bar accessories up to 1/4" x 1"
- Easily attaches to side rails of all North American surgical tables

FACC0004 Straight Bar Accessory Clamp

Surgical Table Accessories

Tri-Clamp

- Designed to provide flexibility
- 3 individual adjustments for lithotomy, abduction & rail securing
- Attaches anywhere on operating table rail
- Patient weight capacity of 350 lbs.
- Used for rectangular blades & round posts

FACCF-TCP2 Tri-Clamp



Simple Clamp

- Innovative design allows placement under/over drapes
- Durable aluminum & stainless steel construction
- Holds all 1/2" to 5/8" (1.3cm - 1.6cm) diameter accessories
- Patient weight capacity of 500 lbs.
- Attaches anywhere on table rail between standoffs

FACC40018 Simple Clamp



Super Clamp

- Multi-positioner clamp
- Solid stainless steel construction
- Effortlessly secures most accessories to siderail of any North American surgical table
- Fits round bars up to 3/4" diameter, straight bars up to 1/4" x 1"
- Accommodates square bar accessories up to 3/4" square

CUCL-7500 Super Clamp



Surgical Table Accessories

FHC offers a full range of armboard surfaces for any type of armboard in both flat and contoured styles to increase patient arm stability. The Softcare and Softcare w/ Gel Surfaces are design to reduce pressure and should be part of your pressure management strategy.

6"
(15cm)



	STANDARD		
	2" Pad (5cm)	3" Pad (8cm)	4" Pad (10cm)
FLAT SURFACE	BB2080AP-2	BB2080AP-3	BB2080AP-4

Fits most standard armboard sizes

(Getinge, Maquet, Shampaine, Amsco, Berchtold, Steris, Skytron)

	DELUXE			DELUXE GEL			
	2" Pad (5cm)	3" Pad (8cm)	4" Pad (10cm)	2.25" Pad (6cm)	3.25" Pad (8cm)	4.25" Pad (11cm)	5.25" Pad (13cm)
FLAT SURFACE	BB2080AP-2D	BB2080AP-3D	BB2080AP-4D	BB2080AP-2DG	BB2080AP-3DG	BB2080AP-4DG	BB2080AP-5DG

	SOFTCARE				SOFTCARE W/ GEL			
	2" Pad (5cm)	3" Pad (8cm)	4" Pad (10cm)	5" Pad (13cm)	2.25" Pad (6cm)	3.25" Pad (8cm)	4.25" Pad (11cm)	5.25" Pad (13cm)
FLAT SURFACE	BB2080AP-DSF	BB2080AP-3SF	BB2080AP-4SF	BB2080AP-5SF	BB2080AP-2SFG	BB2080AP-3SFG	BB2080AP-4SFG	BB2080AP-5SFG

	STANDARD		
	2" Pad (5cm)	3" Pad (8cm)	4" Pad (10cm)
CONTOURED SURFACE	BB2080AP-2C	BB2080AP-3C	BB2080AP-4C

	DELUXE			DELUXE GEL			
	2" Pad (5cm)	3" Pad (8cm)	4" Pad (10cm)	2.25" Pad (6cm)	3.25" Pad (8cm)	4.25" Pad (11cm)	5.25" Pad (13cm)
CONTOURED SURFACE	BB2080AP-2DC	BB2080AP-3DC	BB2080AP-4DC	BB2080AP-2DGC	BB2080AP-3DGC	BB2080AP-4DGC	BB2080AP-5DGC

	SOFTCARE				SOFTCARE W/ GEL			
	2" Pad (5cm)	3" Pad (8cm)	4" Pad (10cm)	5" Pad (13cm)	2.25" Pad (6cm)	3.25" Pad (8cm)	4.25" Pad (4.25)	5.25" Pad (13cm)
CONTOURED SURFACE	BB2080AP-2SFC	BB2080AP-3SFC	BB2080AP-4SFC	BB2080AP-5SFC	BB2080AP-2SFGC	BB2080AP-3SFGC	BB2080AP-4SFGC	BB2080AP-5SFGC

*This Page
Intentionally
Left Blank*