

# Surgical Tables

Future Health Concepts manufactures surgical and operating room tables that are built for today's procedures and patients. We understand that hospitals and surgical centers need medical equipment that meets the demanding needs of modern medicine is critical.

Our FHC1000 Series offers an innovative, compact design while maintaining enough clinical versatility to accommodate surgical procedures in nearly all fields, including urology, neurology, orthopedics and cardiology.

## FHC1000S Surgical Table

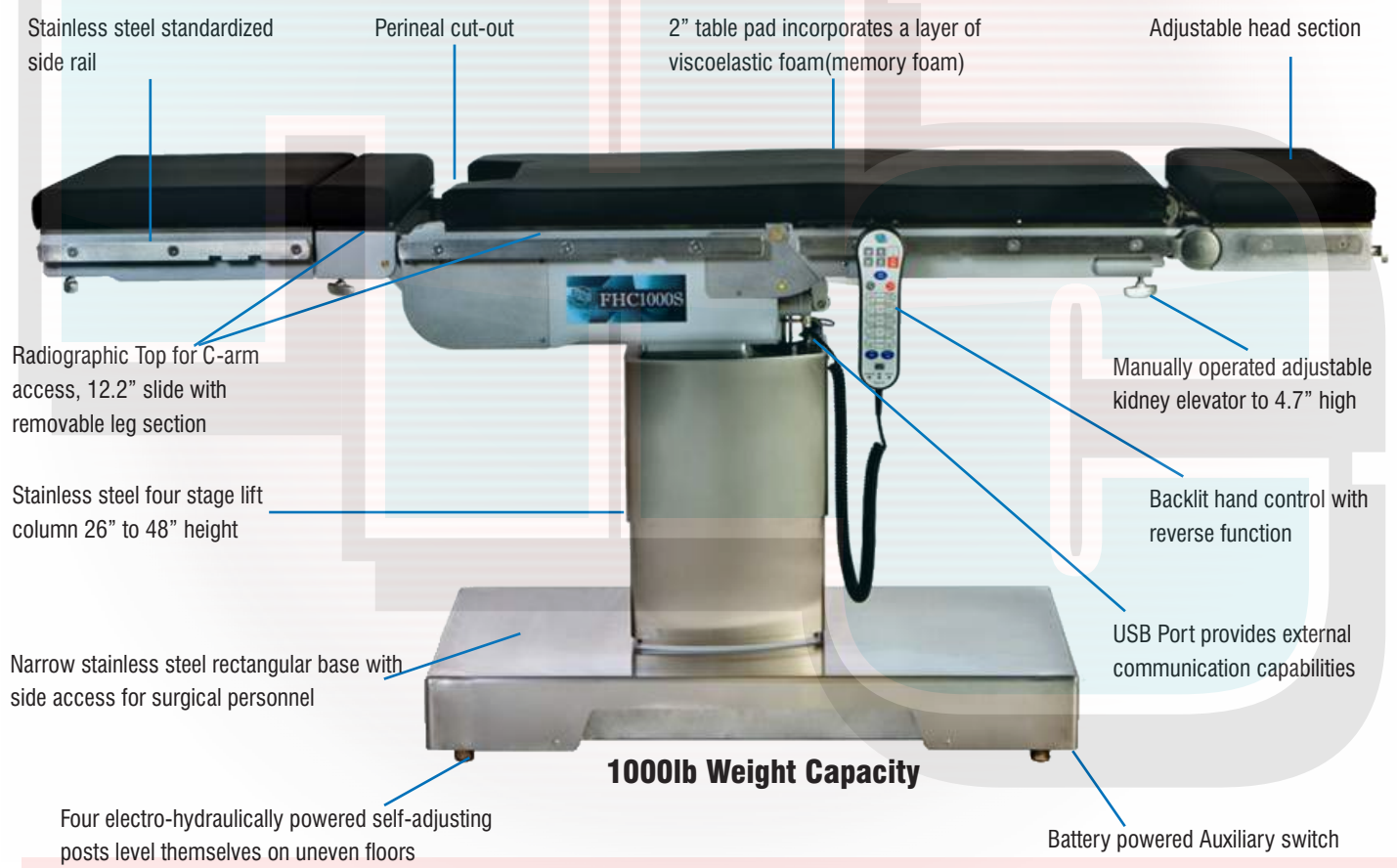

**Lithotomy**



**Neurosurgery**



**Lumbar**

### Electrical Specifications:

Power Requirements:  
 AC 110V/5A, 300W, 50/60Hz or  
 AC 220/3A, 300W, 50/60Hz; single phase

Current Leakage: <100 microamps  
 Power Cord: 15 feet



# Surgical Tables

## C-Arm Imaging for Every Part of the Body

The intelligent design of the table provides benefits such as remarkable C-arm access, self diagnosis with instant error code display and the prevention of sectional conflict.

In addition to the durable, rust-free components, the FHC1000 also incorporates several fail-safe functions to ensure its continuous operation.

### Model # FHC1000S

Normal orientation slid to head end (head + leg extension + table)

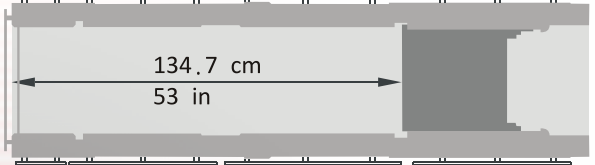

Normal orientation slid to head end

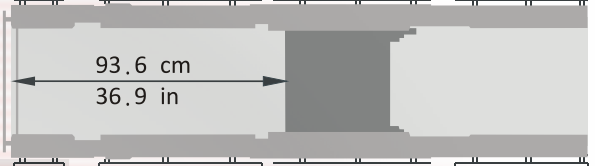

Normal orientation slid to leg end

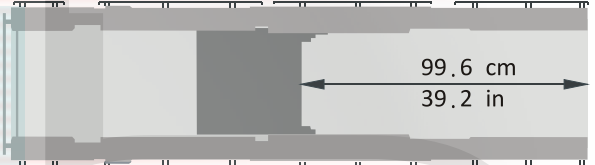

Reverse orientation slid to leg end

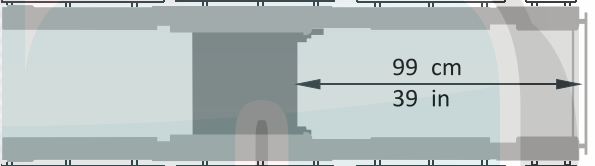

Reverse orientation slid to head end

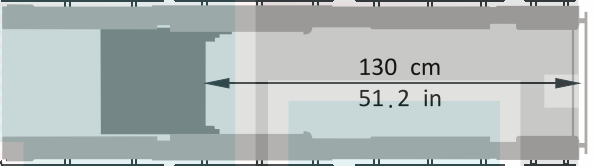

### Model # FHC1000

Normal orientation (head + leg extension + table)

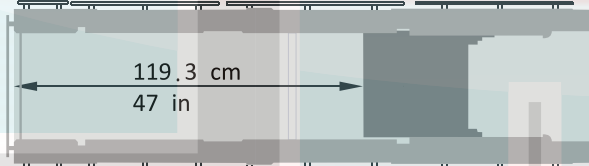

Normal orientation

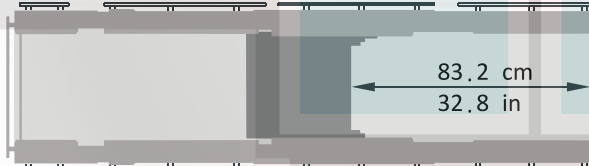

Reverse orientation

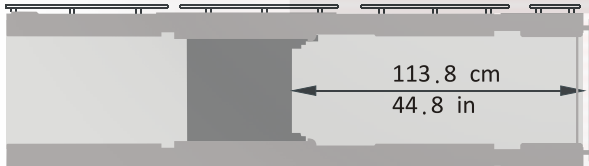

(FHC1000 shown above)



(FHC1000S shown above)

### Override System

The override control system allows operation of basic functions should the hand pendant become inoperative.



# Surgical Tables

## Range of Table Movements

The FHC1000 Series has exceptional positioning capabilities. Designed to simplify patient positioning, the table also features a notably sturdy and low-profile base, ensuring surgeon comfort and therefore reducing fatigue during long procedures.

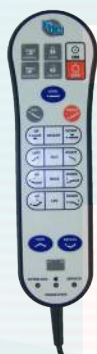

### Hand Pendant

The ergonomic hand pendant's backlit display illuminates the buttons, an essential feature for endoscopic surgery. The intelligent patient orientation function automatically interprets positioning commands according to the selected orientation. Functions such as LOCK, UNLOCK, LEVEL, FLEX, and REFLEX help quick and safe positioning. Most of the possible sectional conflicts are paused by the control system; also the user is informed by the INTERLOCK LED and a warning sound.

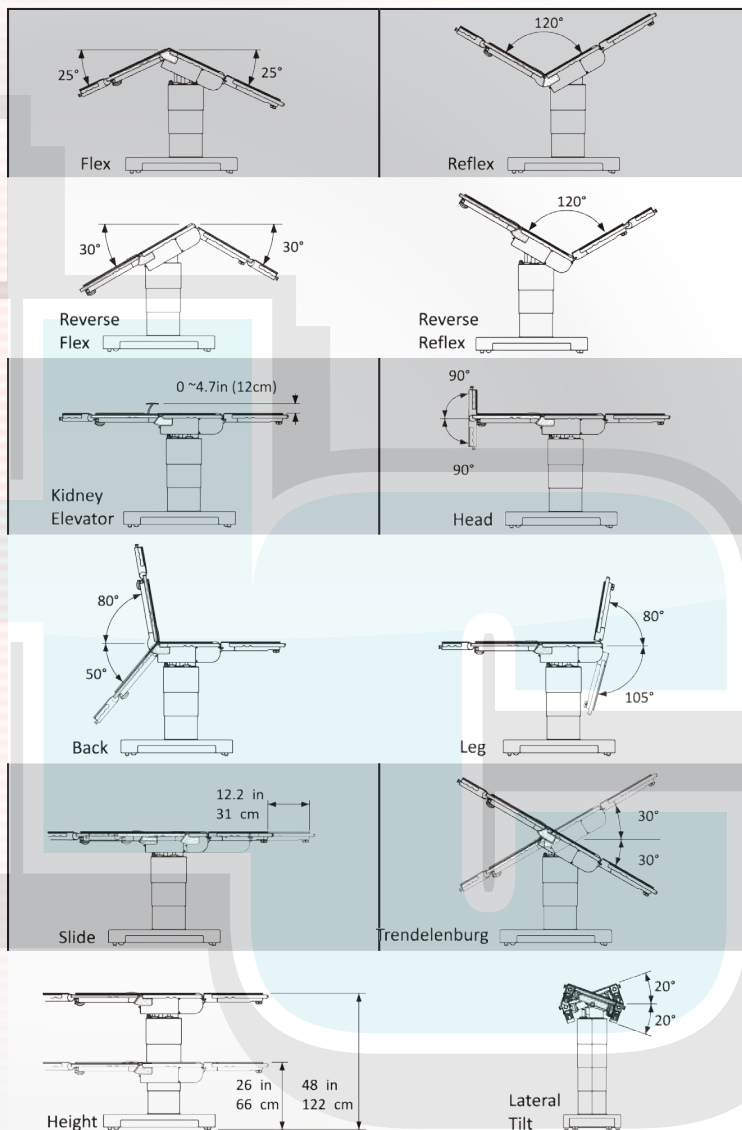

### Foot Pump

A second source of hydraulic power. (optional)



### Self Diagnosis Instant Error Code Display

A battery level indicator on the base panel displays the service code when the Service LED on the hand pendant is lit.



### Built-in X-ray Cassette Channels

Having 14" wide X-ray cassettes channels beneath the entire table length eliminates the need for X-ray tabletops, thus making tabletop articulations possible and increasing patient safety.

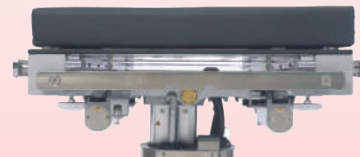

# Surgical Tables

## FUTURE HEALTH CONCEPTS, INC.

Brand/Model		FHC1000	Steris 3085 SP	Maquet 1132 (ALPHASTAR)	Berchtold Operon B810	Berchtold Operon B710	Berchtold Operon D750	
Tabletop	Number of Tabletop Sections	4	4	different options	4	5	4	
	Built-in Kidney Elevator	Yes	Yes	No	Yes	No	Yes	
	Type of Leg Section	Single Plate	Removable extension	Removable	Removable	Removable	Removable	Removable
		Split Plates	Accessory	Accessory	Accessory	No	Accessory	Accessory
	Frame Material	Aluminum Alloy	Aluminum Alloy	Stainless Steel	Aluminum Alloy	Aluminum Alloy	Aluminum Alloy	
	Cassette Tunnel Width	14" entire table	12"	14" entire table	14"	14"	14"	
	Accessory Anti-Falling Device	Yes	Yes	Yes	Yes	Yes	Yes	
	Max. Load lbs (kg)	Normal Orientation	1000 (454)	1000 (454)	990 (450) (for "plus")	600 (273)	770 (350)	750 (341)
Reverse Orientation		1000 (600 when slid)	500 (227)	500 (225)	600 (273)	770 (350)	500 (227)	
Pad	Antistatic Surface	Yes	Yes	Yes	Yes	Yes	Yes	
	Pressure Relief	Yes	Yes	Yes	Yes	Yes	Yes	
	Flame-Retardant (117 & 129)	Yes	Yes	Yes	Yes	Yes	Yes	
Base	Cover Material	SUS # 304	Stainless steel	glass-fiber reinforced	Plastic	Plastic	Plastic	
	Swivel Casters / Straight Casters	4 swivel	4 swivel	4 swivel	4 swivel	4 swivel	4 swivel	
	Number of Floor Posts	4	3	3	4	4	4	
Powered Functions	Floor Locks	Yes	Yes	Yes	Yes	Yes	Yes	
	Height	Yes	Yes	Yes	Yes	Yes	Yes	
	Trendelenburg/Reverse	Yes	Yes	Yes	Yes	Yes	Yes	
	Lateral Tilt	Yes	Yes	Yes	Yes	Yes	Yes	
	Back Section	Yes	Yes	Yes	Yes	Yes	Yes	
	Shoulder Section	N/A	N/A	N/A	N/A	N/A	N/A	
	Leg Section	Yes	Yes	Yes	Yes	Yes	Yes	
	Kidney Elevator	No	No	N/A	Yes	N/A	N/A	
	Longitudinal Slide	N/A	N/A	N/A	Yes	N/A	N/A	
	Table Transport	No	No	Yes, optional	N/A	Yes, optional	N/A	
	Auto Leveling	Yes	Yes	Yes	Yes	Yes	Yes	
	Flex/Reflex	Yes	Yes	Yes	Yes	Yes	Yes	
	Position Memory	No	No	No	No	No	No	
	Self Diagnosis	Integrated Error Codes	No	No	No	External E-service	External E-service	External E-service
Backlit Hand Pendant	Yes	No	Yes	Yes	Yes	No		
Range of movement	Height, inches(mm)	26-48" (660 - 1220)	27-44" (686 - 1118)	depends on model	28 - 48" (700 - 1220)	28 - 45" (710 - 1140)	26 - 40.5" (660 - 1029)	
	Trendelenburg /Reverse	30°/30°	25°/25°	30°/30°	30°/30°	30°/30°	30°/31°	
	Lateral Tilt	20°/20°	18°/18°	18°/18°	20°/20°	20°/20°	20°/20°	
	Back Section	80° to -50°	55° to -25°	68° to -25°	80° to -45°	70° to -70°	90° to -45°	
	Shoulder Section	N/A	N/A	N/A	N/A	N/A	N/A	
	Head Section	90° to -90°	90° to -90°	N/A	90° to -90°	90 to -90	40° to -85°	
	Leg Section	up/down	80° to -105°	80° to -105°	80° to -105°	2° to -105°	70° to -90°	30° to -105°
		left/right	N/A	N/A	N/A	N/A	90°	90°
	Kidney Elevator Height, inch(cm)	4.72" (12)	4" (10)	N/A	3" (7.6)	N/A	3.1" (7.8)	
Longitudinal Sliding, inch(cm)	12"	N/A	N/A	12" (30.5)	N/A	N/A		
Fail Safe	Override Control	Yes	Yes	Yes	Yes	Yes	Yes	
	Built-in Battery	Yes	Yes	Yes	Yes	Yes	Yes	
	Foot Pump	Only for FHC1000SK P	Y	N	Yes	No, but hand-ratchet	No	



# Surgical Tables

FUTURE HEALTH CO  
SETTING THE INDUSTRY

Brand/Model		FHC1000S	Steris Cmax	Steris 5085 SRT	Berchtold Operon D850	
Tabletop	Number of Tabletop Sections		4	4	4	
	Built-in Kidney Elevator		Yes	Yes	Yes	
	Type of Leg Section	Single Plate	Extension is removable	Removable	Removable	Removable
		Split Plates	Accessory	Accessory	Accessory	Accessory
	Frame Material		Aluminum alloy	Stainless steel	Stainless steel	Aluminum Alloy
	Cassette Tunnel Width		14" (36 cm) (entire table)	?	?	14" (36) entire table
	Accessory Anti-Falling Device		Yes	Yes	Yes	Yes
	Max. Load lbs (kg)	Normal Orientation	1000 (454)	1100 (500)	1000 (454)	1000 (454)
Reverse Orientation		600 (273) slid out	600 (273) w/ positioning	600(273) w/ positioning	N/A	
Pad	Antistatic Surface		Yes	Yes	Yes	
	Pressure Relief		Yes	Yes	Yes	
	Flame-Retardant (117 & 129)		Yes	Yes	Yes	
Base	Cover Material		SUS #304	SUS #304	SUS #304	Plastic
	Swivel Casters / Straight Casters		Apr-00	Apr-00	Apr-00	Apr-00
	Number of Floor Posts		4, self-leveling	4, self-leveling	4, self-leveling	4, self-leveling
Powered Functions	Floor Locks		Yes	Yes	Yes	Yes
	Height		Yes	Yes	Yes	Yes
	Trendelenburg/Reverse		Yes	Yes	Yes	Yes
	Lateral Tilt		Yes	Yes	Yes	Yes
	Back Section		Yes	Yes	Yes	Yes
	Shoulder Section		N/A	N/A	N/A	N/A
	Leg Section		Yes	Yes	Yes	Yes
	Kidney Elevator		No	Yes	Yes	Yes
	Longitudinal Slide		Yes	Yes	Yes	Yes
	Table Transport		No	No	Yes	Yes
	Auto Leveling		Yes	Yes	Yes	Yes
	Flex/Reflex		Yes	Yes	Yes	Yes
	Position Memory		No	No	No	No
	Self Diagnosis		Integrated error code	External e-service	External e-service	External E-service
	Backlit Hand Pendant		Yes	No	No	Yes
Range of movement	Height, inches(mm)		26"- 48" (660 - 1220)	26"- 45" (675 - 1136)	22.8"- 42.5" (581-1080)	22.6" - 46.4" (570-1180)
	Trendelenburg /Reverse		30°/30°	30°/30°	30°/30°	30°/31°
	Lateral Tilt		20°/ 20°	20°/ 20°	20°/ 20°	20°/20°
	Back Section		80° to -50°	90° to -40°	80° to -40°	90° to -45°
	Shoulder Section		N/A	N/A	N/A	N/A
	Head Section		90° to -90°	90 to -90°	60° to -90°	90° to -90°
	Leg Section	up/down	80° to -105°	0 to -105°	0 to -105°	0° to -105°
		left/right	N/A	N/A	N/A	N/A
	Kidney Elevator Height, inch(cm)		4.72" (12)	4.33" (11)	4.33" (11)	3.7" (9.4)
Longitudinal Sliding, inch(cm)		12.2" (31)	18" (45.4)	18" (45.4)	17" (43)	
Fail Safe	Override Control		Y	Y	Y	Yes
	Built-in Battery		Y	Y	Y	Yes
	Foot Pump		Only for FHC1000SKP	Y	N	Yes

# Surgical Tables

CONCEPTS, INC.  
STANDARD

800.282.8644 | [www.fhcusa.com](http://www.fhcusa.com)

1211 E. 30th Street | Sanford, FL 32773

Maquet 1133	Trumpf Titan	Skytron 6701	Skytron 6002	Skytron 3501
4 (+options)	2 (+ options)	4	4	3
No	No	Yes	Yes	N/A
N/A	N/A	N/A	N/A	N/A
Removable	Removable	N/A	N/A	N/A
Aluminum Alloy	Stainless Steel	N/A	N/A	N/A
14" (36) entire table	?	N/A	N/A	N/A
Yes	No	Yes	Yes	Yes
792 (360)	990 (450)	1200	600	700
N/A	N/A	1000 articulate	600	600
Yes	Yes	N/A	N/A	N/A
Yes	No	N/A	N/A	N/A
?	No	N/A	N/A	N/A
Fiberglass?	SUS #304	N/A	N/A	N/A
Apr-00	Apr-00	N/A	N/A	N/A
3	4	4	4	4
Yes	Yes	Yes	Yes	Yes
Yes	Yes	Yes	Yes	Yes
Yes	Yes	Yes	Yes	Yes
Yes	Yes	Yes	Yes	Yes
Yes	Yes	Yes	Yes	Yes
No	No	N/A	N/A	N/A
Yes	Yes	Yes	Yes	Yes
N/A	N/A	Yes	Yes	N/A
Yes	Yes	Yes	N/A	Yes
Optional	Yes	N/A	N/A	N/A
Yes	Yes	Yes	Yes	Yes
Yes	Yes	Yes	Yes	Yes
Yes	No	N/A	N/A	N/A
Viewed on wall mount	External E-service	N/A	N/A	N/A
No	No	Yes	N/A	Yes
23" – 42"(594 – 1056)	25" – 44" (630 – 1130)	23"-41"	28"-43"	26"-45"
30°/30°	40°/40°	30°/30°	30°/30°	25°/20°
20°/20°	25°/25°	30°	30°	30°
80° to -40°	85° to -45°	90° to -40°	90° to -40°	90° to -40°
90° to -45° (manual)	90° to -60° (manual)	N/A	N/A	N/A
45° to -45°	?	N/A	N/A	N/A
10° to -90°	90° to -90°	20° to -100°	horizontal to -105°	2° to -98°
90°, double joints	90°, double joints	N/A	N/A	N/A
N/A	N/A	4.5"	4.5"	N/A
9" (23)	12" (30)	N/A	N/A	21"
Yes	Yes	N/A	N/A	N/A
Yes	Yes	Yes	Yes	N/A
No, but hand-ratchet	No	N/A	N/A	N/A

# Surgical Tables



BI058-840

## **Biodex C-Arm 840 Surgical Table:**

- Low attenuation carbon fiber tabletop, w/ choice of standard contoured or rectangular design
- Contoured tabletop features face cutout for comfortable prone positioning
- High-speed actuators assure quick, 3 axis, motorized, tabletop positioning
- Includes hand & foot-operated controllers
- Free-float X-Y tabletop
- 500-lb patient capacity
- Low profile base for C-Arm clearance
- Accessory rails
- Both AC & battery power are standard

The Biodex 846 Surgical C-Arm Table is designed for procedures where stability, access and precise, quiet, vibration-free positioning are essential. A cantilevered low attenuation carbon fiber tabletop, w/ choic of contoured or rectangular design, accommodates portable or ceiling-suspended C-Arms. The standard contoured top of the Biodex 846 surgical table, allows ample workspace for anesthesiologists, yet the narrowness required for cervical procedures. The rectangular top offers additional space to allow for superior image quality for long-leg runoff studies and is an ideal surgical table for both pain care and cardiovascular applications.

The Biodex Surgical C-Arm Table 840 is designed for image-guided procedures where stability, access, and precise, quite, vibration-free positioning are essential. A cantilevered low attenuation carbon fiber tabletop, w/ choice of contoured or rectangular design, accommodates portable or ceiling-suspended C-Arms. The extra-large radiolucent area, free-float X-Y tabletop, motorized control of height, lateral roll, Trendelenburg motions and catheter tray extension make the Biodex 840 Surgical C-Arm Table ideal for cardiovascular procedures.



BI058-846

## **Biodex C-Arm 846 Surgical Table:**

- Low attenuation carbon fiber tabletop, w/ choice of standard contoured or rectangular design
- Contoured tabletop features face cutout for comfortable prone positioning
- High-speed actuators assure quick, 3 axis, motorized, tabletop positioning
- Includes hand & foot-operated controllers
- Free-float X-Y tabletop
- 500-lb patient capacity
- Low profile base for C-Arm clearance
- Accessory rails

# Surgical Tables



BI058-870

## **Biodex Pain Management C-Arm 870 Surgical Table:**

- Measures 93" L x 26" with OR accessory rails
- Table top measures: 90" L x 24" W
- 2" thick mattress
- Height adjustable from 30" to 40"
- Trendelenburg 0° to 20°
- Reverse trendelenburg 0° to 20°
- Lateral roll 0° to 20°
- Hand control actuates all motions
- Locking 5" swivel casters
- 500 lb. weight capacity
- 115 VAC or 230 VAC
- Low profile base for C-arm clearance

The Biodex Pain Management C-Arm 870 operating table is carefully constructed to provide enhanced stability, access, and precise, quiet, vibration-free positioning during usage. With a low attenuation carbon fiber tabletop and high-speed actuators for quick, three axis motorized tabletop positioning, the Pain Management C-arm surgical table ensures each operator gets flexible and easy pain care management available. A 2 inch thick mattress and 500 pound weight capacity provides comfortability for even some of the heaviest patients. The choice of standard contoured or rectangular design allows customers to select the tabletop that best fits the need to achieve maximum image resolution.



BI058-800

## **Biodex C-Arm 800 Urology Table:**

- Large radiolucent area, 54" x 17.5"
- Fowler positioning (0° to 80°)
- 5 axis motorized tabletop positioning
- Hand-held & foot-operated controllers
- Smooth starts and stops programmed into all motorized movements
- Low profile base for C-Arm clearance
- Accessory rails
- Both AC and battery power are standard

The Biodex 800 Urology C-Arm Table is an ideal choice for image-guided procedures. The narrow Fiberesin(TM) tabletop is cantilevered to accommodate portable or ceiling suspended C-Arms. The urology table also features motorized actuation of height, X-Y, lateral roll and Trendelenburg motions of the tabletop. The table comes equipped with a lightweight, non-imaging patient transfer extension and a radiolucent extension. With standard Both AC and battery power, the Biodex 800 Urology Table provides functional designs for complete access while minimizing radiation exposure to clinicians.



# Surgical Tables



BI058-810

## **Biodex C-Arm 810 Brachytherapy Table:**

- Large radiolucent area, 54" x 17.5"
- Fowler positioning (0° to 80°)
- 5 axis motorized tabletop positioning
- Hand-held & foot-operated controllers
- Smooth starts and stops programmed into all motorized movements
- Low profile base for C-Arm clearance
- Accessory rails
- Both AC and battery power are standard

The Biodex C-Arm 820 3D Imaging Table is designed and equipped for use with 3D C-Arm for seed implantation, urology, thoracic/vascular and other general C-Arm applications. The table features motorized actuation of height, X-Y, lateral roll and Trendelenburg motions of the tabletop. The hand-held and foot-operated controllers can be positioned for access from any point around the table and ensure quick and safe tabletop positioning during any phase of a procedure. The 3D Imaging Table comes equipped with a lightweight, non-imaging patient transfer extension and a radiolucent extension.

Designed and equipped specifically for seed implantation procedures, the Biodex 810 Brachytherapy C-Arm Table features a radiolucent extension that provides capability for brachytherapy treatment involving the upper body and general C-Arm applications. Motorized actuation of height, X-Y, lateral roll and Trendelenburg motions of the tabletop, with pre-programmed features, ensure quick and safe tabletop positioning during any phase of a procedure. The Brachytherapy table comes equipped with a lightweight non-imaging patient transfer extension and a radiolucent extension. A standard OR accessory rail makes stepper positioning quick and easy.



BI058-820

## **Biodex C-Arm 820 3D Imaging Table:**

- Large radiolucent area, total length 51.5"
- 5 axis motorized tabletop positioning
- Low attenuation carbon fiber tabletop
- Hand-held & foot-operated controllers
- Smooth starts and stops programmed into all motorized movements
- Low profile base for C-Arm clearance
- Exceptional platform for pelvic Brachytherapy & 3D Urology procedures
- Ideal for 3D imaging of breasts and thorax
- Accessory rails
- Both AC and battery power are standard

# Surgical Tables

## Carbon Fiber X-Ray Imaging Table:

- Diving board style for easy c-arm access
- Large patient capacity- 500 pound load
- 2" patient high quality comfort pad
- Facial Cut-out for prone procedures
- Lightweight - easy to physically move the table
- 24" top eliminates need for arm boards
- Simple to use top quality wheel locks
- Easy patient transfer to table

Carbon fiber top of 24" width eliminates need for armboards and 84" length can accommodate even the tallest patients

(Vascular & Urology Imaging X-Ray Tables also available)

Face Access Hole

Easy to use handswitch with power on indicator

2" thick high quality patient comfort pad

FHC-SUSL

High end actuator motor can lift over 500 pound load

Lightweight, which makets it easy for staff to move the table around the room or room to room

## FHC Streamline SUSL-1 Imaging Table:

High-low 28" to 38" 120v

## FHC Streamline SUSL-2 Imaging Table:

High-low 28" to 38", and lateral tilt (+-) 17°, 120v,

## FHC Streamline SUSL-3 Imaging Table:

High-low 28" to 38", lateral tilt (+-) 17°, and trendelenburg (+-) 20°, 120v

## FHC Streamline SUSL-4 Imaging Table:

High-low 28" to 38", lateral tilt (+-) 17°, and trendelenburg (+-) 20°, and longitudinal slide of 10" head to foot (plus or minus 5"), 120v

## FHC Streamline SUSL-5 Imaging Table:

High-low 28" to 38", lateral tilt (+-) 17°, and trendelenburg (+-) 20°, longitudinal slide of 10" head to foot (plus or minus 5"), and lateral side to side 10" (plus or minus 5"), 120v

**\*Three Year Parts & Labor Warranty**

# Surgical Tables

We carry pads for all your favorite brand name surgical tables as well as customizable pads for manufacturers' we may not have!

Berchtold B810, B710

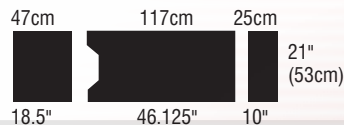

Midmark Chic CST

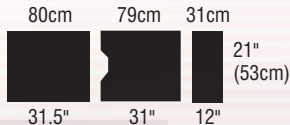

Skytron 3501B



Berchtold Operon D850, D750

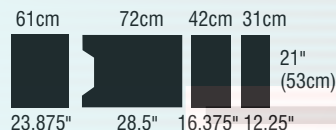

Midmark Montreal

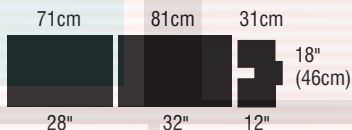

Skytron 3600



Maquet/Siemens 1130

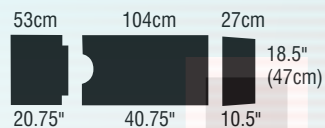

Getinge/Shampaine 1400/1500/1900

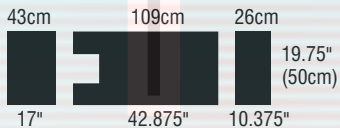

Skytron 6700, 6701



Maquet 1130 Split Leg

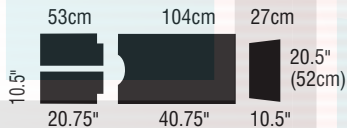

Getinge/Shampaine 1501 Radi-Op

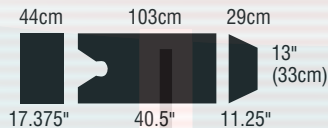

Steris-Amsco 1080, 2080



Maquet 1130 Orthopedic

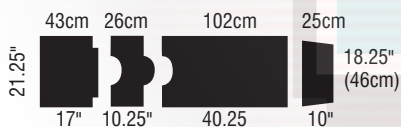

Getinge/Shampaine 4900/5100B, 5100E

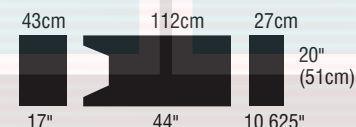

Steris-Amsco 1080, 2080 w/Leg Ext.



Maquet Alphamaxx



Skytron 5001, 6001, 6500, 6600



Steris-Amsco 3080, 3085

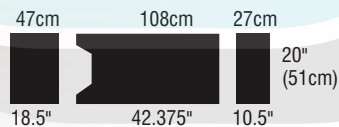

Maquet Alphastar 1132

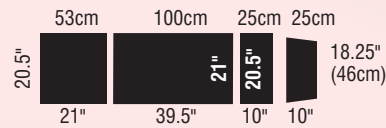

Skytron 3100

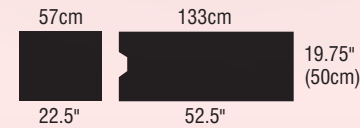

Steris-C-Max

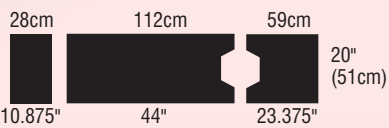

Midmark 7100

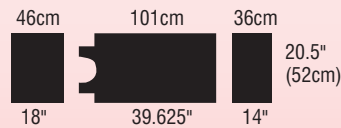

Skytron 3500

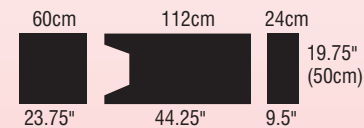

Steris Surgi-Graphic 6000

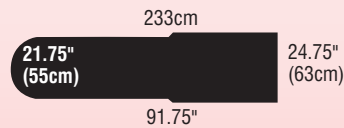

# Surgical Tables

## Types of Surgical Table Pads:

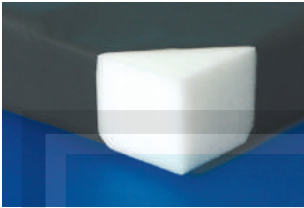

### Standard

Consists of standard open cell high density polyurethane foam with a Lectrolite™ Cover. Meets OEM Specifications.

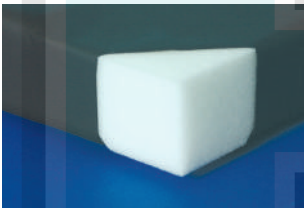

### Deluxe

Consists of standard open cell high density polyurethane foam with a multidirectional stretch anti-shear Fusion™ Cover. Exceeds OEM specifications.



### Deluxe Gel

consists of standard open cell high density polyurethane foam support layer with a top layer of polymer gel all covered with a multidirectional stretch anti-shear Fusion™ Cover.



### Softcare

Consists of high density polyurethane foam support layer with a top layer of memory foam covered with a multidirectional stretch anti-shear Fusion™ Cover. Exceeds OEM specifications.



### Softcare w/ Gel

Consists of a closed cell rubber anti-bottoming layer then a high density polyurethane foam support layer with a top layer of memory foam covered with a multidirectional stretch anti-shear Fusion™ Cover.



# Surgical Tables

		STANDARD		DELUXE		DELUXE GEL				
		US	2"	3"	2"	3"	2.25"	3.25"	4.25"	5.25"
		METRIC	5cm	8cm	5cm	8cm	6cm	8cm	11cm	13cm
A	Berchtold B810, B710	BBB810	BBB810-3	BBB810D	BBB810D-3	BBB810DG	BBB810DG-3	BBB810DG-4	BBB810DG-5	
B	Berchtold Operon D850, D750	BBD850	BBD850-3	BBD850D	BBD850D-3	BBD850DG	BBD850DG-3	BBD850DG-4	BBD850DG-5	
C	Maquet/Siemens 1130	BB1130	BB1130-3	BB1130D	BB1130-3	BB1130DG	BB1130DG-3	BB1130DG-4	BB1130DG-5	
D	Maquet 1130 Split Leg	BB1130-SL	BB1130-SL-3	BB1130-SLD	BB1130-SLD-3	BB1130-SLDG	BB1130-SLDG-3	BB1130-SLDG-4	BB1130-SLDG-5	
E	Maquet 1130 Orthopedic	BB1130-0	BB1130-0-3	BB1130-0D	BB1130-0D-3	BB1130-0DG	BB1130-0DG-3	BB1130-0DG-4	BB1130-0DG-5	
F	Maquet Alphamaxx	BBALPMAX	BBALPMAX-3	BBALPMAX-D	BBALPMAX-D3	BBALPMAX-DG	BBALPMAX-DG3	BBALPMAX-DG4	BBALPMAX-DG5	
G	Maquet Alphastar 1132	BBALPSTR	BBALPSTR-3	BBALPSTR-D	BBALPSTR-D3	BBALPSTR-DG	BBALPSTR-DG3	BBALPSTR-DG4	BBALPSTR-DG5	
H	Midmark 7100	BBMI7100	BBMI7100-3	BBMI7100-D	BBMI7100-D3	BBMI7100-DG	BBMI7100-DG3	BBMI7100-DG4	BBMI7100-DG5	
I	Midmark Chic CST	BBMIDCST	BBMIDCST-3	BBMIDCST-D	BBMIDCST-D3	BBMIDCST-DG	BBMIDCST-DG3	BBMIDCST-DG4	BBMIDCST-DG5	
J	Midmark Montreal	BBMIMONT	BBMIMONT-3	BBMIMONT-D	BBMIMONT-D3	BBMIMONT-DG	BBMIMONT-DG3	BBMIMONT-DG4	BBMIMONT-DG5	
K	Getinge/Shampaine 1400/1500/1900	BB1400	BB1400-3	BB1400-D	BB1400-D3	BB1400-DG	BB1400-DG3	BB1400-DG4	BB1400-DG5	
L	Getinge/Shampaine 1501 Radi-Op	BB1501	BB1501-3	BB1501-D	BB1501-D3	BB1501-DG	BB1501-DG3	BB1501-DG4	BB1501-DG5	
M	Getinge/Shampaine 4900/5100B, 5100E	BB4900	BB4900-3	BB4900-D	BB4900-D3	BB4900-DG	BB4900-DG3	BB4900-DG4	BB4900-DG5	
N	Skytron 5001, 6001, 6500, 6600	BB5001	BB5001-3	BB5001-D	BB5001-D3	BB5001-DG	BB5001-DG3	BB5001-DG4	BB5001-DG5	
O	Skytron 3100	BB3100	BB3100-3	BB3100-D	BB3100-D3	BB3100-DG	BB3100-DG3	BB3100-DG4	BB3100-DG5	
P	Skytron 3500	BB3500	BB3500-3	BB3500-D	BB3500-D3	BB3500-DG	BB3500-DG3	BB3500-DG4	BB3500-DG5	
Q	Skytron 3501B	BB3501B	BB3501B-3	BB3501B-D	BB3501B-D3	BB3501B-DG	BB3501B-DG3	BB3501B-DG4	BB3501B-DG5	
R	Skytron 3600	BB3600	BB3600-3	BB3600-D	BB3600-D3	BB3600-DG	BB3600-DG3	BB3600-DG4	BB3600-DG5	
S	Skytron 6700, 6701	BB6700	BB6700-3	BB6700-D	BB6700-D3	BB6700-DG	BB6700-DG3	BB6700-DG4	BB6700-DG5	
T	Steris-Amsco 1080, 2080	BB2080	BB2080-3	BB2080-D	BB2080-D3	BB2080-DG	BB2080-DG3	BB2080-DG4	BB2080-DG5	
U	Steris-AMSCO 1080/2080 w/Leg Ext.	BB2080L	BB2080L-3	BB2080L-D	BB2080L-D3	BB2080L-DG	BB2080L-DG3	BB2080L-DG4	BB2080L-DG5	
V	Steris-Amsco 3080, 3085	BB3080	BB3080-3	BB3080D	BB3080D-3	BB3080DG	BB3080DG-3	BB3080DG-4	BB3080DG-5	
W	Steris C-Max	BBCMAX	BBCMAX-3	BBCMAXD	BBCMAXD-3	BBCMAXDG	BBCMAXDG-3	BBCMAXDG-4	BBCMAXDG-5	
X	Steris Surgi-Graphic 6000	BB6000	BB6000-3	BB6000D	BB6000D-3	BB6000DG	BB6000DG-3	BB6000DG-4	BB6000DG-5	

# Surgical Tables

		SOFTCARE				SOFTCARE W/ GEL				
		US	2"	3"	4"	5"	2.25"	3.25"	4.25"	5.25"
		Metric	5cm	8cm	10cm	13cm	6cm	8cm	11cm	13cm
A	Berchtold B810, B710	BBB810SF	BBB810SF-3	BBB810SF-4	BBB810SF-5	BBB810SF-G	BBB810SF-G-3	BBB810SF-G-4	BBB810SF-G-5	
B	Berchtold Operon D850, D750	BBD850SF	BBD850SF-3	BBD850SF-4	BBD850SF-5	BBD850SF-G	BBD850SF-G-3	BBD850SF-G-4	BBD850SF-G-5	
C	Maquet/Siemens 1130	BB1130SF	BB1130SF-3	BB1130SF-4	BB1130SF-5	BB1130SF-G	BB1130SF-G-3	BB1130SF-G-4	BB1130SF-G-5	
D	Maquet 1130 Split Leg	BB1130-SLSF	BB1130-SLSF-3	BB1130-SLSF-4	BB1130-SLSF-5	BB1130-SLSF-G	BB1130-SLSFG-3	BB1130-SLSFG-4	BB1130-SLSFG-5	
E	Maquet 1130 Orthopedic	BB1130-O-SF	BB1130-O-SF3	BB1130-O-SF4	BB1130-O-SF5	BB1130-O-SFG	BB1130-O-SFG3	BB1130-O-SFG4	BB1130-O-SFG5	
F	Maquet Alphamaxx	BBALPMAX-SF	BBALPMAX-SF3	BBALPMAX-SF4	BBALPMAX-SF5	BBALPMAX-SFG	BBALPMAX-SFG3	BBALPMAX-SFG4	BBALPMAX-SFG5	
G	Maquet Alphastar 1132	BBALPSTR-SF	BBALPSTR-SF3	BBALPSTR-SF4	BBALPSTR-SF5	BBALPSTR-SFG	BBALPSTR-SFG3	BBALPSTR-SFG4	BBALPSTR-SFG5	
H	Midmark 7100	BBMI7100-SF	BBMI7100-SF3	BBMI7100-SF4	BBMI7100-SF5	BBMI7100-SFG	BBMI7100-SFG3	BBMI7100-SFG4	BBMI7100-SFG5	
I	Midmark Chic CST	BBMIDCST-SF	BBMIDCST-SF3	BBMIDCST-SF4	BBMIDCST-SF5	BBMIDCST-SFG	BBMIDCST-SFG3	BBMIDCST-SFG4	BBMIDCST-SFG5	
J	Midmark Montreal	BBMIMONT-SF	BBMIMONT-SF3	BBMIMONT-SF4	BBMIMONT-SF5	BBMIMONT-SFG	BBMIMONT-SFG3	BBMIMONT-SFG4	BBMIMONT-SFG5	
K	Getinge/Shampaine 1400/1500/1900	BB1400SF	BB1400SF-3	BB1400SF-4	BB1400SF-5	BB1400SFG	BB1400SFG-3	BB1400SFG-4	BB1400SFG-5	
L	Getinge/Shampaine 1501 Radi-Op	BB1501SF	BB1501SF-3	BB1501SF-4	BB1501SF-5	BB1501SFG	BB1501SFG-3	BB1501SFG-4	BB1501SFG-5	
M	Getinge/Shampaine 4900/5100B, 5100E	BB4900SF	BB4900SF-3	BB4900SF-4	BB4900SF-5	BB4900SFG	BB4900SFG-3	BB4900SFG-4	BB4900SFG-5	
N	Skytron 5001, 6001, 6500, 6600	BB5001SF	BB5001SF-3	BB5001SF-4	BB5001SF-5	BB5001SFG	BB5001SFG-3	BB5001SFG-4	BB5001SFG-5	
O	Skytron 3100	BB3100SF	BB3100SF-3	BB3100SF-4	BB3100SF-5	BB3100SFG	BB3100SFG-3	BB3100SFG-4	BB3100SFG-5	
P	Skytron 3500	BB3500SF	BB3500SF-3	BB3500SF-4	BB3500SF-5	BB3500SFG	BB3500SFG-3	BB3500SFG-4	BB3500SFG-5	
Q	Skytron 3501B	BB3501B-SF	BB3501B-SF3	BB3501B-SF4	BB3501B-SF5	BB3501B-SFG	BB3501B-SFG3	BB3501B-SFG4	BB3501B-SFG5	
R	Skytron 3600	BB3600SF	BB3600SF-3	BB3600SF-4	BB3600SF-5	BB3600SFG	BB3600SFG-3	BB3600SFG-4	BB3600SFG-5	
S	Skytron 6700, 6701	BB6700SF	BB6700SF-3	BB6700SF-4	BB6700SF-5	BB6700SFG	BB6700SFG-3	BB6700SFG-4	BB6700SFG-5	
T	Steris-Amsco 1080, 2080	BB2080SF	BB2080SF-3	BB2080SF-4	BB2080SF-5	BB2080SFG	BB2080SFG-3	BB2080SFG-4	BB2080SFG-5	
U	Steris-AMSCO 1080/2080 w/Leg Ext.	BB2080L-SF	BB2080L-SF3	BB2080L-SF4	BB2080L-SF5	BB2080L-SFG	BB2080L-SFG3	BB2080L-SFG4	BB2080L-SFG5	
V	Steris-Amsco 3080, 3085	BB3080SF	BB3080SF-3	BB3080SF-4	BB3080SF-5	BB3080SFG	BB3080SFG-3	BB3080SFG-4	BB3080SFG-5	
W	Steris C-Max	BBCMAX-SF	BBCMAX-SF3	BBCMAX-SF4	BBCMAX-SF5	BBCMAX-SFG	BBCMAX-SFG3	BBCMAX-SFG4	BBCMAX-SFG5	
X	Steris Surgi-Graphic 6000	BB6000SF	BB6000SF-3	BB6000SF-4	BB6000SF-5	BB6000SFG	BB6000SFG-3	BB6000SFG-4	BB6000SFG-5	